



SCAN THIS CODE OR VISIT  
**WILDWESTEXODUS.COM**  
 FOR ASSEMBLY GUIDES AND MORE!

WEX991399031



# WILD WEST EXODUS

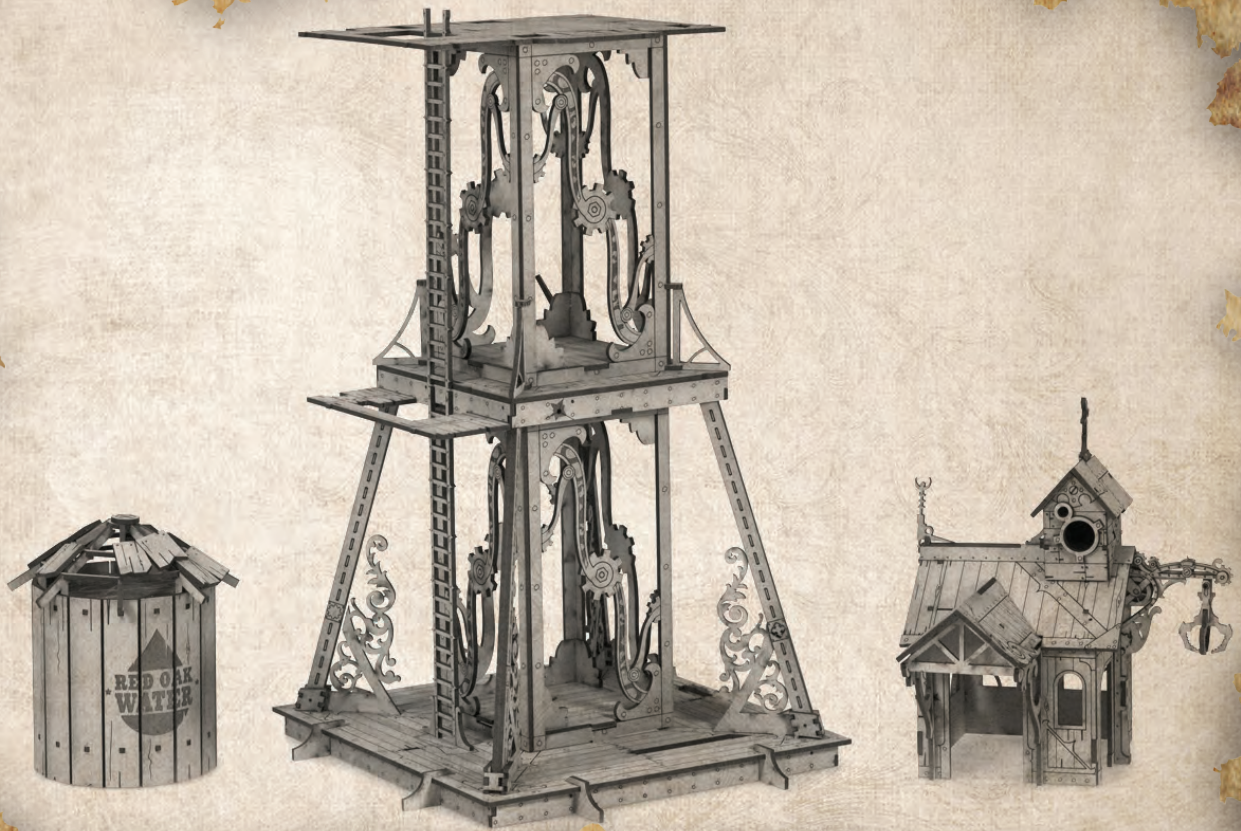

# RED OAK WATCHTOWER

PART OF THE **DYSTOPIAN AGE**



@WILDWESTEXODUS



@WARCRADLESTUDIOS



WARNING! NOT A TOY. AGE 14+  
 HOBBY GAMING PRODUCT  
 CONTAINS SMALL PARTS



ACHTUNG! KEIN SPIELZEUG. ALTER 14+  
 HOBBY SPIELPRODUKT  
 ENTHÄLT KLEINE TEILE



PRECAUCIÓN! NO ES UN JUGUETE EDADES. 14+  
 PRODUCTO DE HOBBY  
 CONTIENE PIEZAS PEQUEÑAS



ATTENTION! PAS UN JOUET. ANS 14+  
 PRODUIT DE JEU HOBBY  
 CONTIENT DE PETITES PIÈCES

THIS PRODUCT CONTAINS MEDIUM DENSITY FIBREBOARD (CLASS E1)



WARCRADLE STUDIOS IS A TRADING NAME OF WAYLAND GAMES LIMITED. WILD WEST EXODUS IS A TRADEMARK OF WAYLAND GAMES LIMITED.  
 ILLUSTRATIONS AND DESIGNS ARE COPYRIGHT © 2021 WAYLAND GAMES LIMITED. MADE IN THE UK.





Parts may need careful removal from the MDF boards with a scalpel, and light sanding of any rough edges. We recommend testing assembling sections before permanently gluing together.

**1**

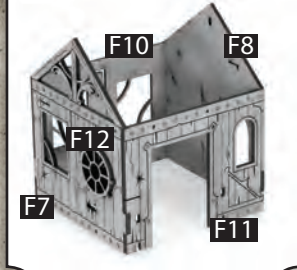

- Combine F7, F8, F10 & F11 as shown.
- Glue F12 to F7.

**2**

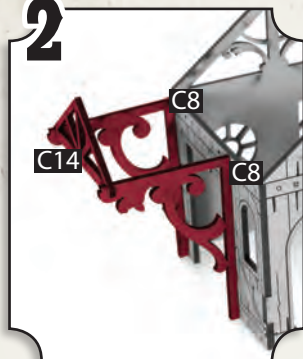

- Connect 2x C8 to F11.
- Connect C14 to 2x C8.

**3**

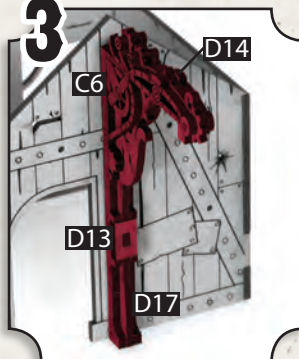

- Connect D17 to F8.
- Glue C6 & D14 either side of D17.
- Connect D13 to D17.

**4**

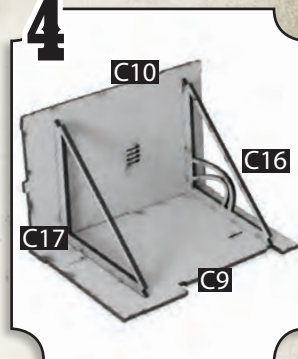

- Combine C9, C10, C16 & C17 as shown.

**5**

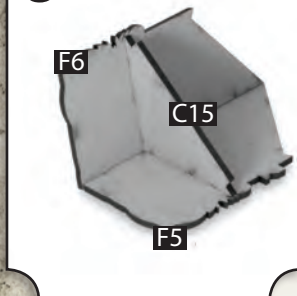

- Combine C15, F5 & F6 as shown.

**6**

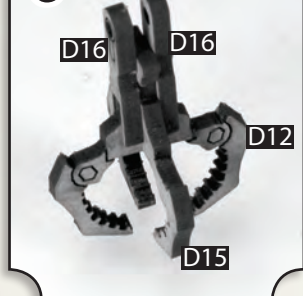

- Slot D15 & D12 together.
- Slot 2x D16 onto D12.

**7**

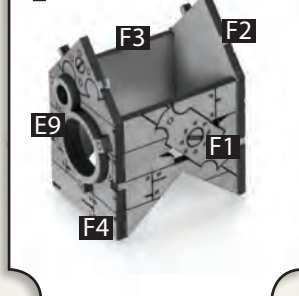

- Combine F1, F2, F3 & F4 as shown.
- Glue E9 to F4.

**8**

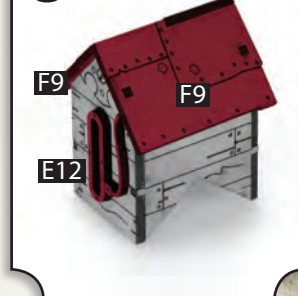

- Connect 2x F9 to the small structure.
- Glue E12 to F2.

**9**



- Place, don't glue, large roof (i) then small roof (ii) onto the shack.
- Glue the small structure (iii) onto large roof.
- Connect the crane claw to crane arm as shown.
- Glue A10 onto large roof.

**10**



- Weather vane: E7 & 2x E8.
- Corner detail: E15 & E14
- Antenna: E13 & E14
- These can all be glued where wanted.

**11**

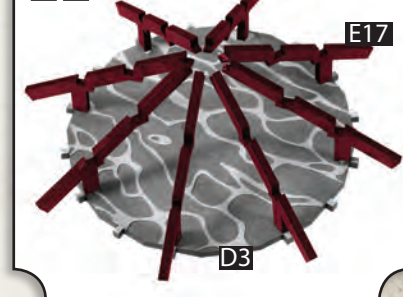

- Connect 8x E17 to D3. Connections will be tight, each E17 piece may need some light sanding.





Parts may need careful removal from the MDF boards with a scalpel, and light sanding of any rough edges. We recommend testing assembling sections before permanently gluing together.

**12**

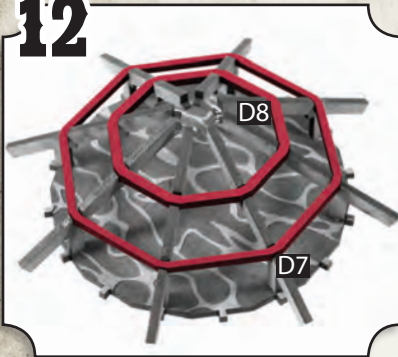

•Connect D7, then D8 to the E17s.

**13**

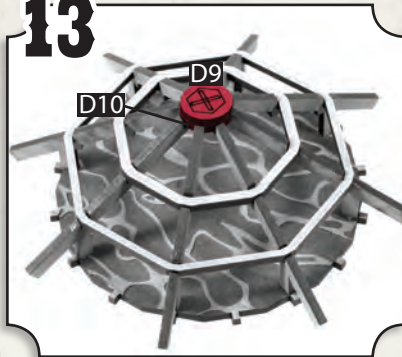

•Glue D10 into the top of the structure.  
•Glue D9 onto D10.

**14**

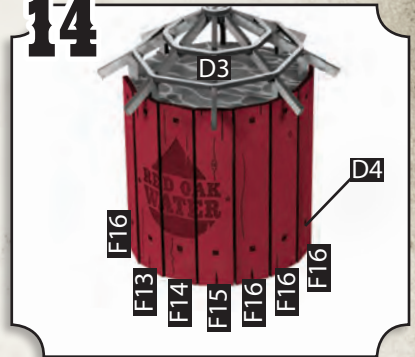

•Connect the water-tower planks as shown, to D3 & D4.  
•Repeat on other side.

**15**



•Tiles (parts labelled C7) can be glued in any way to form the roof.

**16**

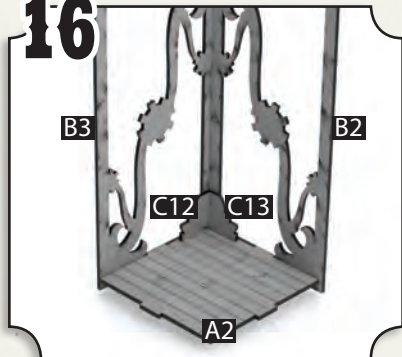

•Connect B2 & B3 to A2.  
•Connect C12 to C13 and glue in the corner as shown.

**17**

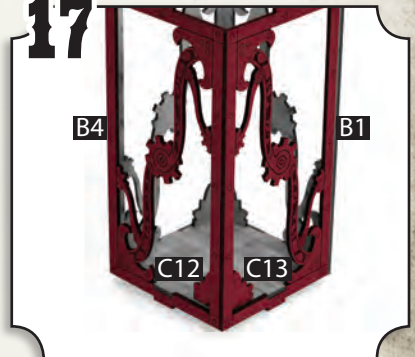

•Connect B1 & B4 to A2.  
•Connect C12 to C13 and glue in the corner as shown.

**18**

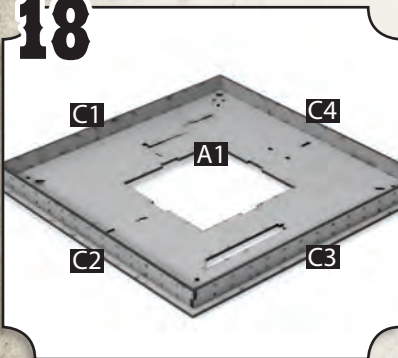

•Connect C1, C2, C3 & C4 to the underside of A1.

**19**

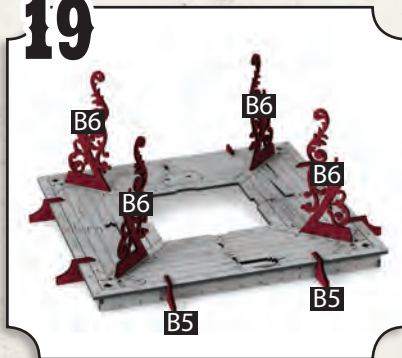

•Connect 8x B5 around the edge of A1.  
•Connect 4x B6 to A1.

**20**

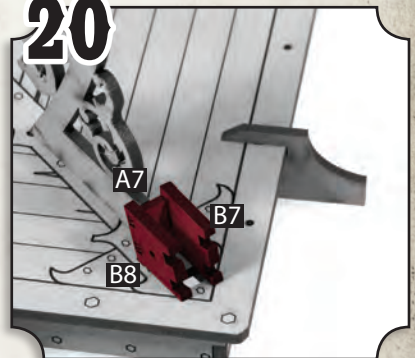

•Spare parts are included to customise your set, (parts A8, A9, A10, A11, A12, A17, A19 & B10).





Parts may need careful removal from the MDF boards with a scalpel, and light sanding of any rough edges. We recommend testing assembling sections before permanently gluing together.

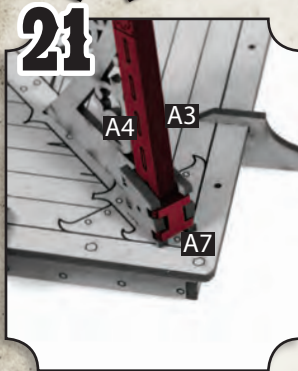

- Slot 8x B9 onto the staircase to form the steps.
- Glue B15 on top.
- Repeat steps 20 & 21 for the remaining three corners.



- Connect the tower to the base (A1) as shown.



- Connect A6 to the top of the tower.
- Ensure that both details labelled with a '!' are on the same side of the tower.

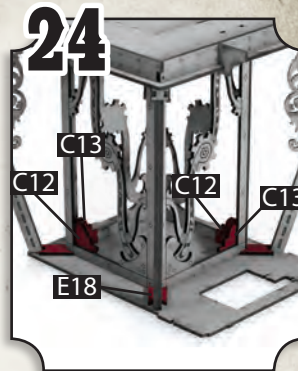

- Connect C12 to C13 and glue in the two corners shown.
- Glue E18 on each corner of the tower as shown. Glue between E18 and support struts.

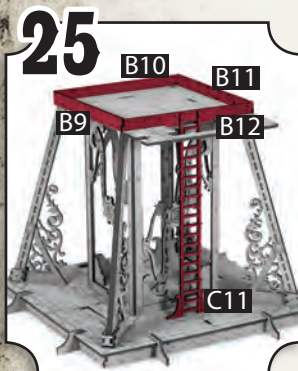

- Attach B9, B10, B11 & B12 to A6.
- Connect C11 to A1

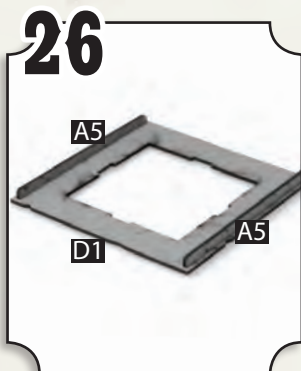

- Connect 2x A5 to D1.

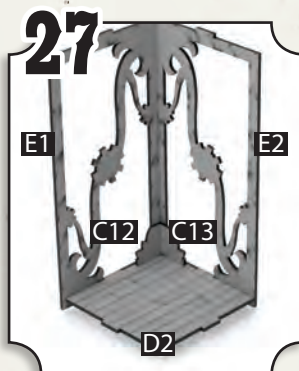

- Connect E1 & E2 to D2.
- Connect C12 to C13 and glue in the corner as shown.



- Connect E3 & E4 to D2.
- Connect C12 to C13 and glue in the corner as shown.

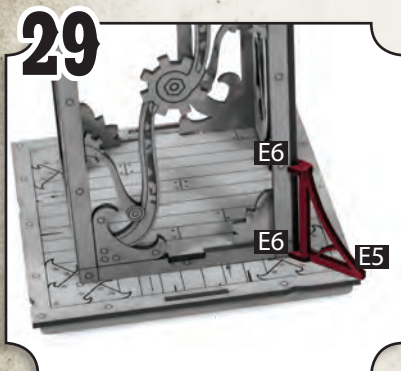

- Combine 2x E6 to E5 and glue in the corner indicated.
- Repeat for the other three corners.

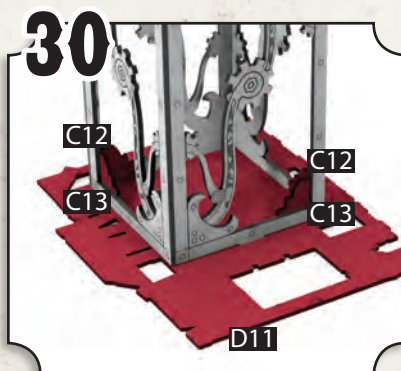

- Connect tower to D11.
- Connect a C12 to C13.
- Connect another C12 to C13 and glue in the two corners shown.



- Connect the ladder (E16).
- Spare parts are included to customise your set, (parts A8, A9, C5, D5, D6, E10 & E11).