

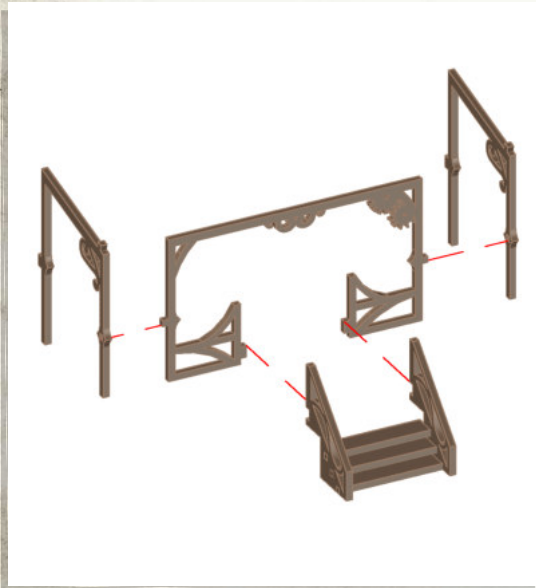

WARCRADLETM
SCENICS

Retribution - Residence - Assembly Guide

Warning: Pushing parts out by hand may cause damage. Parts may need careful removal from the MDF boards with a scalpel, and light sanding of any rough edges. We recommend testing assembling sections before permanently gluing together.

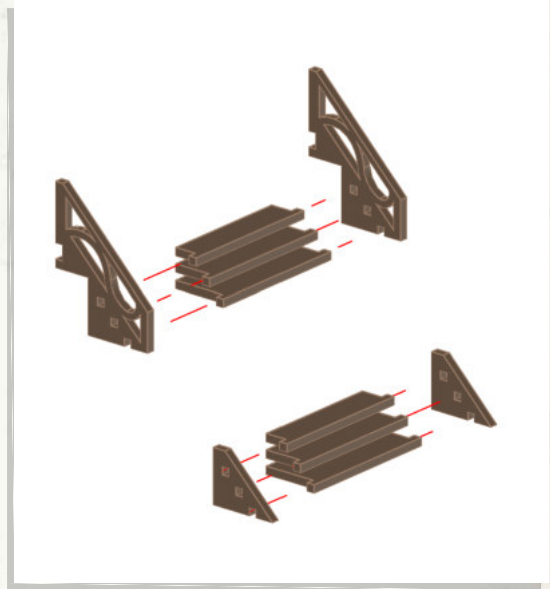
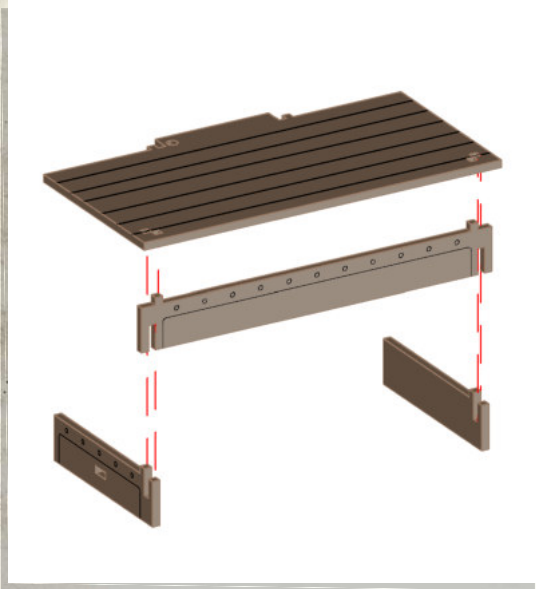

WARCRADLE STUDIOS IS A TRADING NAME OF WAYLAND GAMES LIMITED. WILD WEST EXODUS IS A TRADING NAME OF WAYLAND GAMES LIMITED. ILLUSTRATIONS AND DESIGNS ARE COPYRIGHT © 2020 WAYLAND GAMES LIMITED, ASSEMBLED IN THE UK.



WARCRADLETM
SCENICS

Retribution - Residence - Assembly Guide

Warning: Pushing parts out by hand may cause damage. Parts may need careful removal from the MDF boards with a scalpel, and light sanding of any rough edges. We recommend testing assembling sections before permanently gluing together.

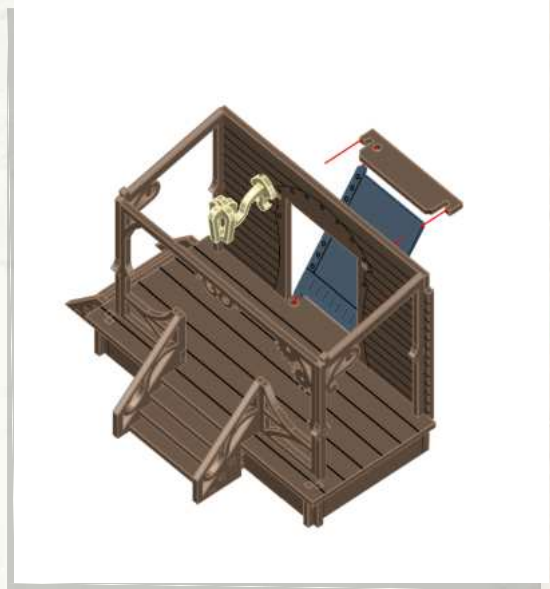
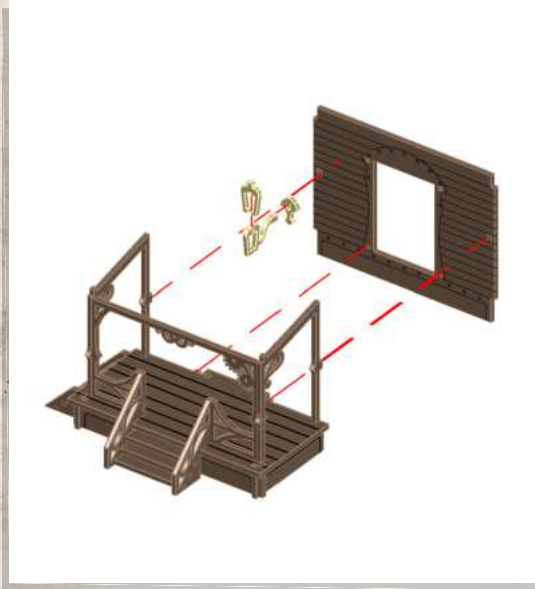

NOTE: Fit the door between the two door hinge holes without glue

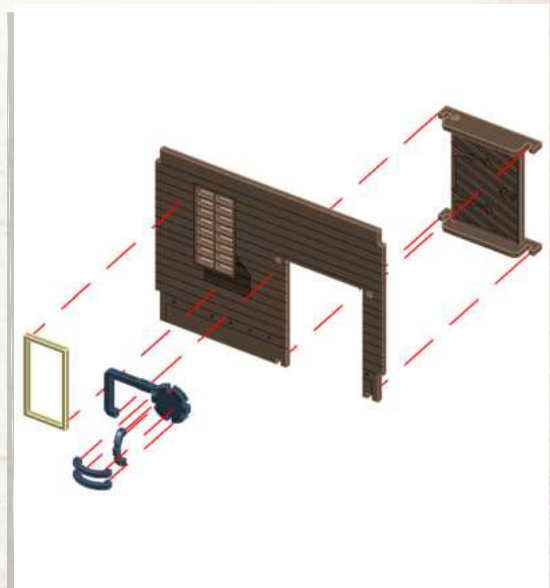
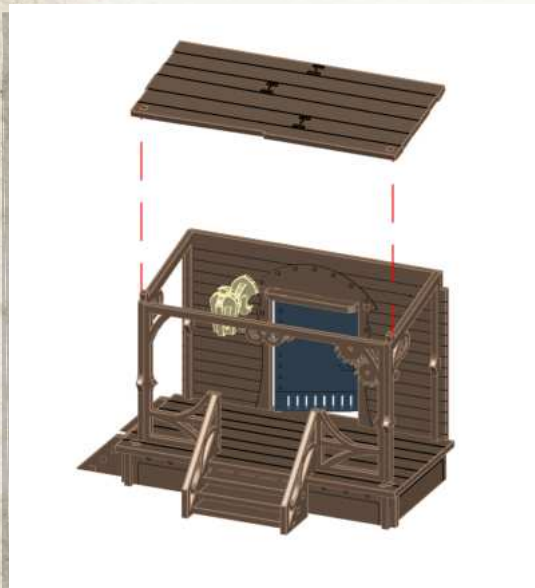



WARCRADLETM
SCENICS

Retribution - Residence - Assembly Guide

Warning: Pushing parts out by hand may cause damage. Parts may need careful removal from the MDF boards with a scalpel, and light sanding of any rough edges. We recommend testing assembling sections before permanently gluing together.

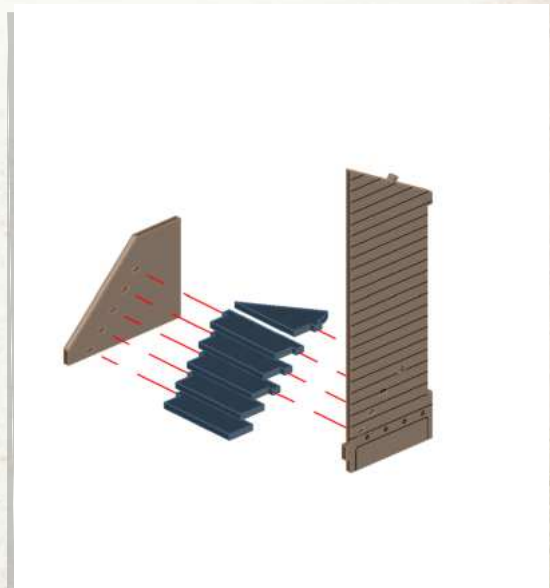
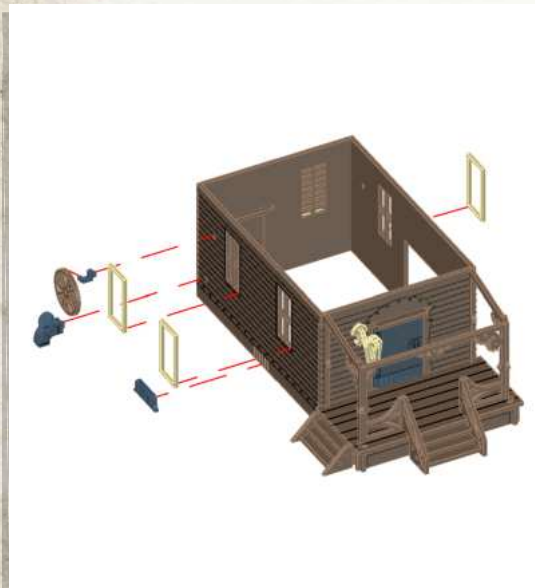
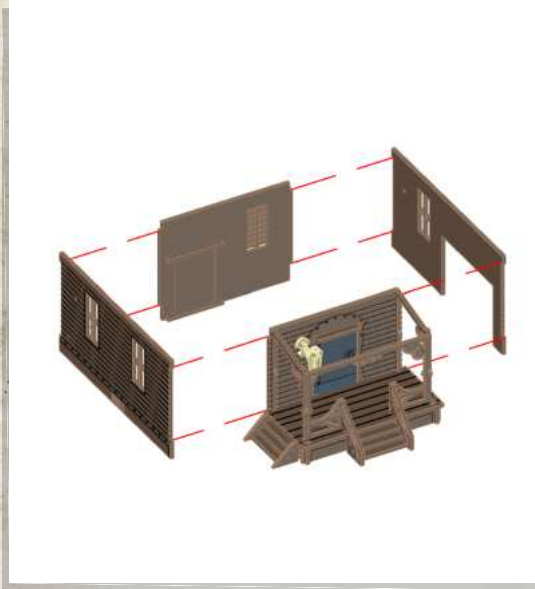



WARCRADLETM
SCENICS

Retribution - Residence - Assembly Guide

Warning: Pushing parts out by hand may cause damage. Parts may need careful removal from the MDF boards with a scalpel, and light sanding of any rough edges. We recommend testing assembling sections before permanently gluing together.

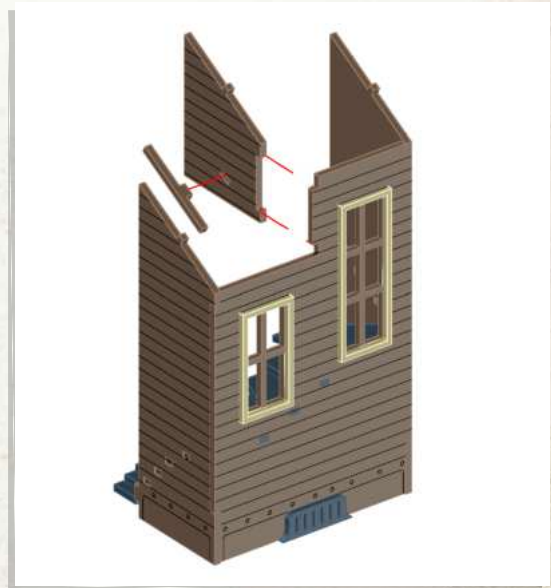
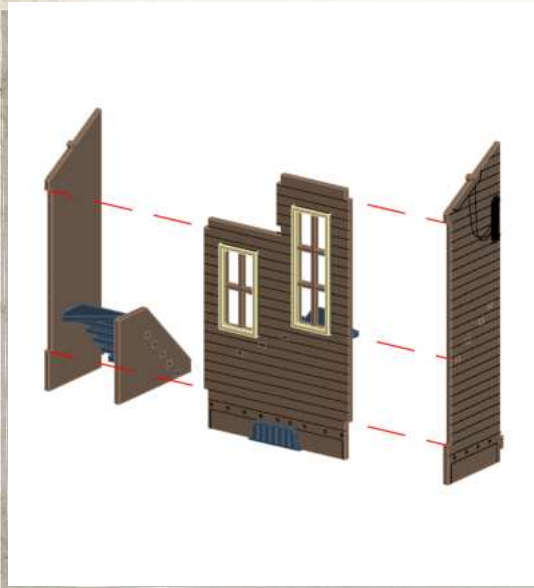
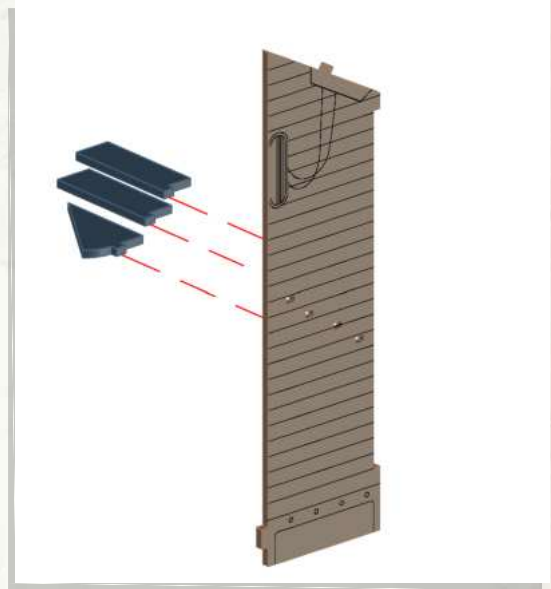
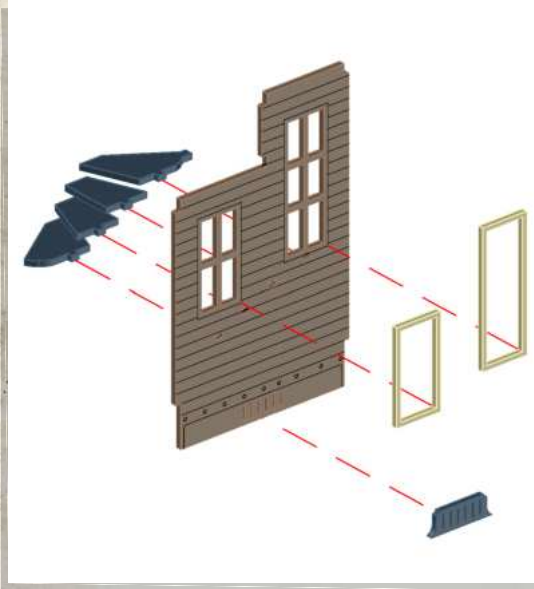



Retribution - Residence - Assembly Guide

Warning: Pushing parts out by hand may cause damage. Parts may need careful removal from the MDF boards with a scalpel, and light sanding of any rough edges. We recommend testing assembling sections before permanently gluing together.

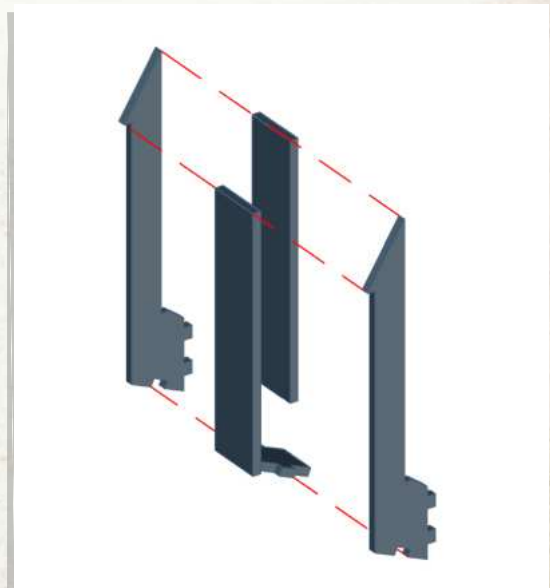
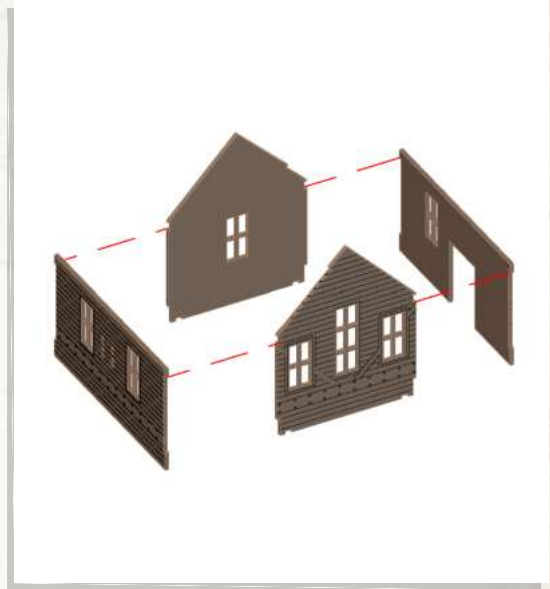



WARCRADLETM
SCENICS

Retribution - Residence - Assembly Guide

Warning: Pushing parts out by hand may cause damage. Parts may need careful removal from the MDF boards with a scalpel, and light sanding of any rough edges. We recommend testing assembling sections before permanently gluing together.

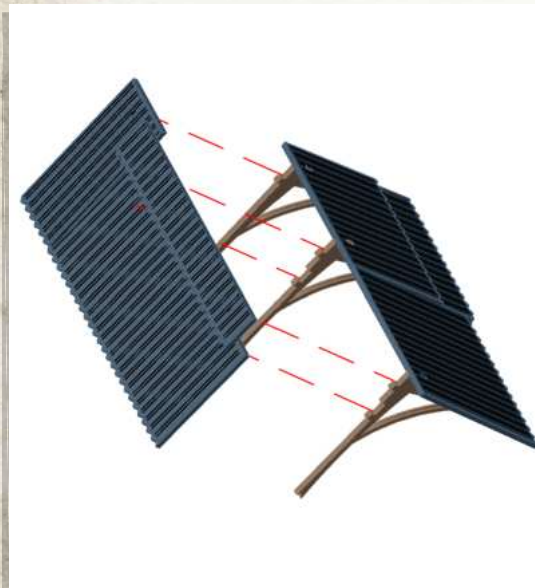
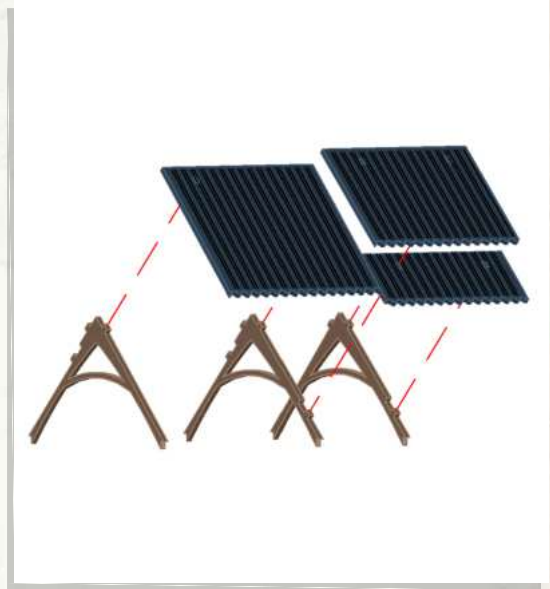
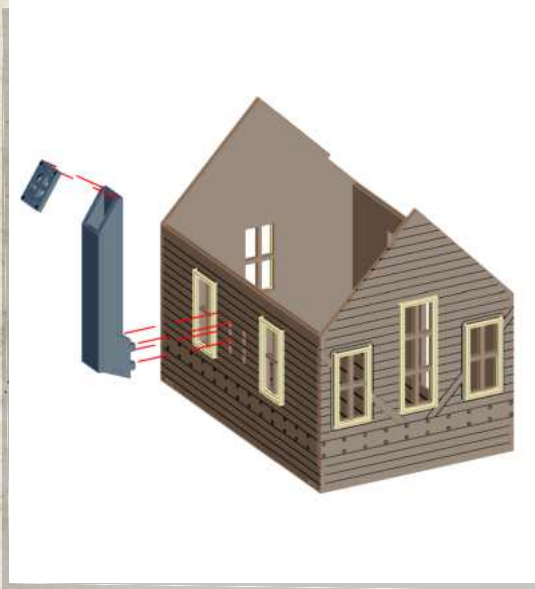

NOTE: Do not glue



WARCRADLETM
SCENICS

Retribution - Residence - Assembly Guide

Warning: Pushing parts out by hand may cause damage. Parts may need careful removal from the MDF boards with a scalpel, and light sanding of any rough edges. We recommend testing assembling sections before permanently gluing together.

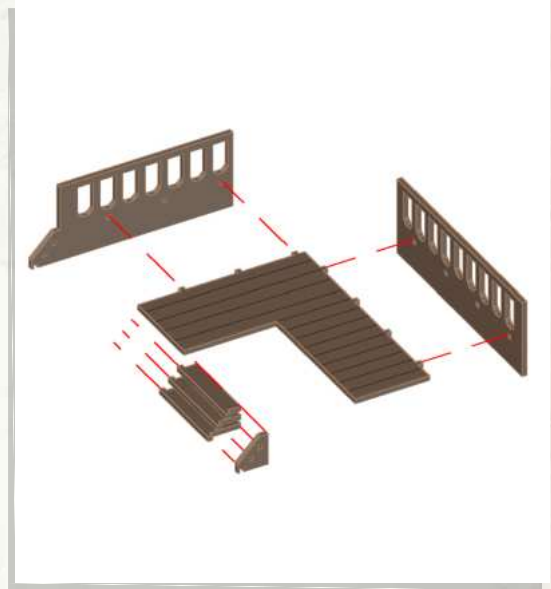
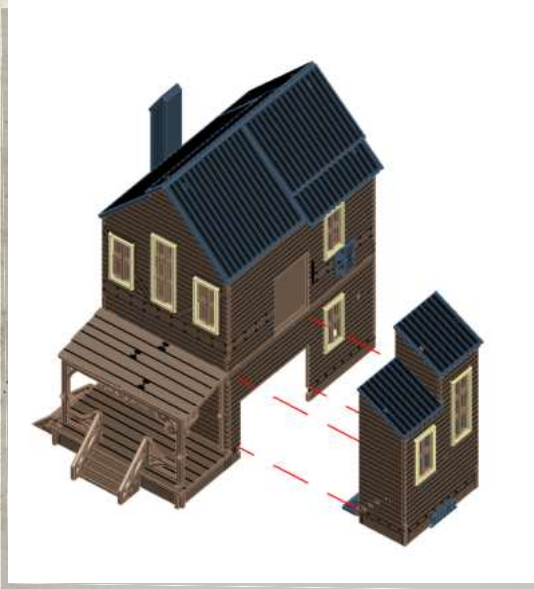

NOTE: Only glue to the lower wall

