

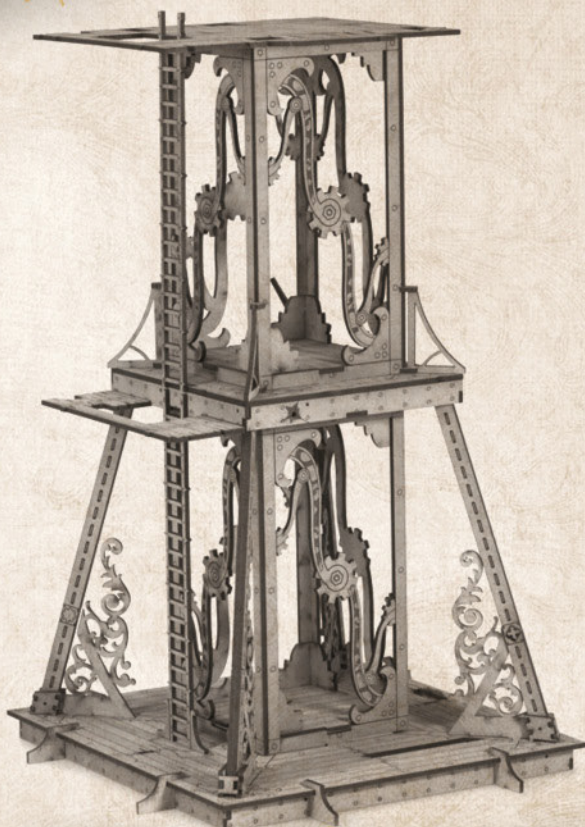

SCAN THIS CODE OR VISIT
WILDWESTEXODUS.COM
 FOR ASSEMBLY GUIDES AND MORE!

WEX991399031

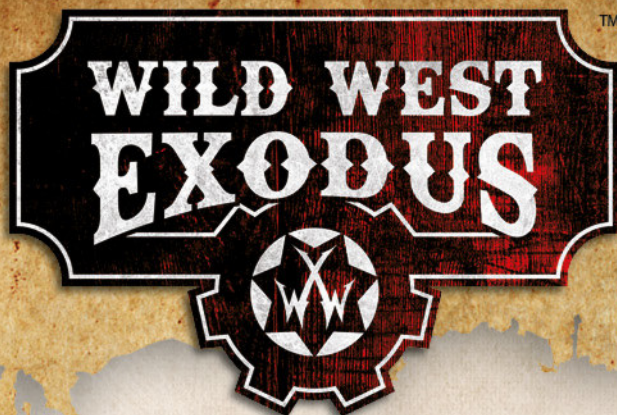

RED OAK WATCHTOWER

PART OF THE **DYSTOPIAN AGE**



@WILDWESTEXODUS



@WARCRADLESTUDIOS



WARNING! NOT A TOY. AGE 14+
 HOBBY GAMING PRODUCT
 CONTAINS SMALL PARTS



ACHTUNG! KEIN SPIELZEUG. ALTER 14+
 HOBBY SPIELPRODUCT
 ENTHÄLT KLEINE TEILE



PRECAUCIÓN! NO ES UN JUGUETE EDADES. 14+
 PRODUCTO DE HOBBY
 CONTIENE PIEZAS PEQUEÑAS



ATTENTION! PAS UN JOUET. ANS 14+
 PRODUIT DE JEU HOBBY
 CONTIENT DE PETITES PIÈCES

THIS PRODUCT CONTAINS MEDIUM DENSITY FIBREBOARD (CLASS E1)



WARCRADLE STUDIOS IS A TRADING NAME OF WAYLAND GAMES LIMITED. WILD WEST EXODUS IS A TRADEMARK OF WAYLAND GAMES LIMITED.
 ILLUSTRATIONS AND DESIGNS ARE COPYRIGHT © 2018 WAYLAND GAMES LIMITED. ASSEMBLED IN THE UK.



Parts may need careful removal from the MDF boards with a scalpel, and light sanding of any rough edges. We recommend testing assembling sections before permanently gluing together.

1

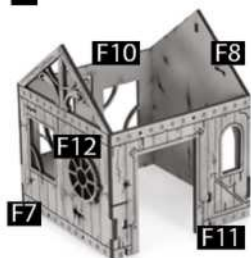

- Combine F7, F8, F10 & F11 as shown.
- Glue F12 to F7.

2

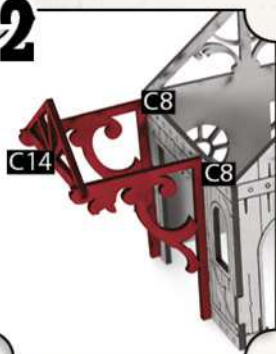

- Connect 2x C8 to F11.
- Connect C14 to 2x C8.

3

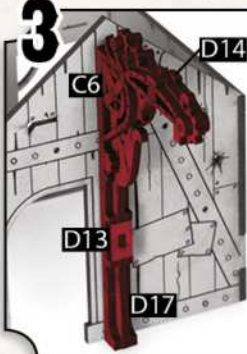

- Connect D17 to F8.
- Glue C6 & D14 either side of D17.
- Connect D13 to D17.

4

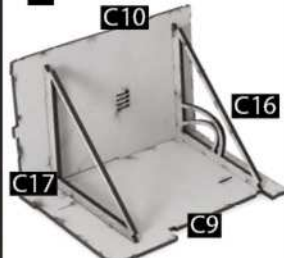

- Combine C9, C10, C16 & C17 as shown.

5

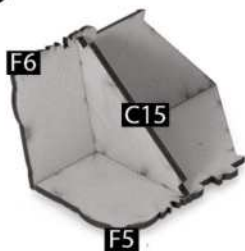

- Combine C15, F5 & F6 as shown.

6



- Slot D15 & D12 together.
- Slot 2x D16 onto D12.

7



- Combine F1, F2, F3 & F4 as shown.
- Glue E9 to F4.

8

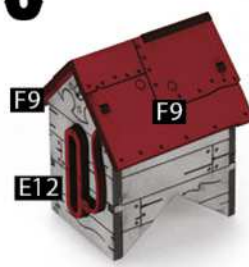

- Connect 2x F9 to the small structure.
- Glue E12 to F2.

9

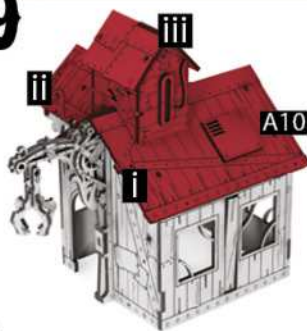

- Place, don't glue, large roof (i) then small roof (ii) onto the shack.
- Glue the small structure (iii) onto large roof.
- Connect the crane claw to crane arm as shown.
- Glue A10 onto large roof.

10

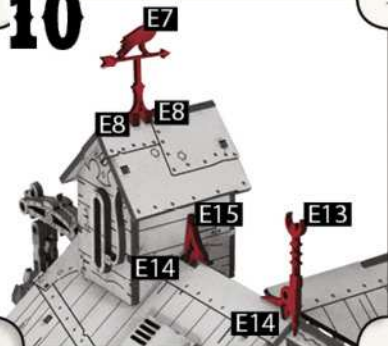

- Weather vane: E7 & 2x E8.
- Corner detail: E15 & E14
- Antenna: E13 & E14
- These can all be glued where wanted.

11

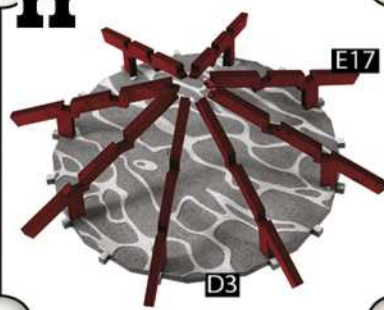

- Connect 8x E17 to D3. Connections will be tight, each E17 piece may need some light sanding.



Parts may need careful removal from the MDF boards with a scalpel, and light sanding of any rough edges. We recommend testing assembling sections before permanently gluing together.

12

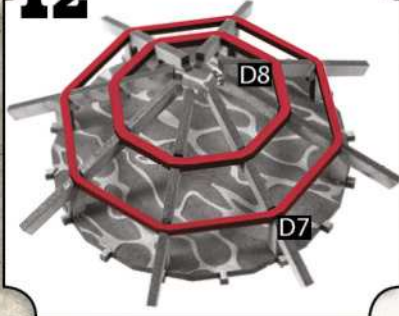

•Connect D7, then D8 to the E17s.

13



•Glue D10 into the top of the structure.
•Glue D9 onto D10.

14

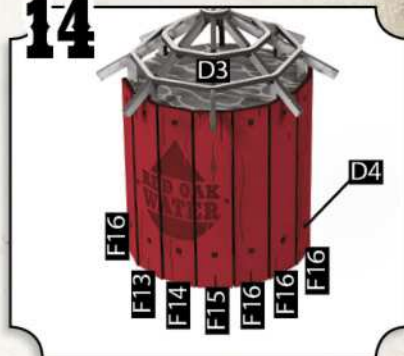

•Connect the water-tower planks as shown, to D3 & D4.
•Repeat on other side.

15



•Tiles (parts labelled C7) can be glued in any way to form the roof.

16

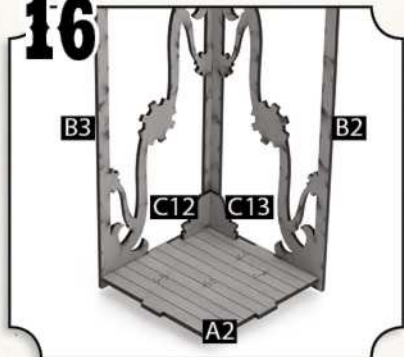

•Connect B2 & B3 to A2.
•Connect C12 to C13 and glue in the corner as shown.

17

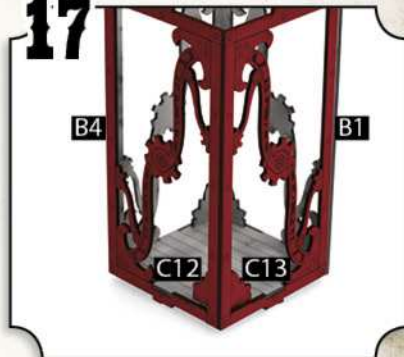

•Connect B1 & B4 to A2.
•Connect C12 to C13 and glue in the corner as shown.

18

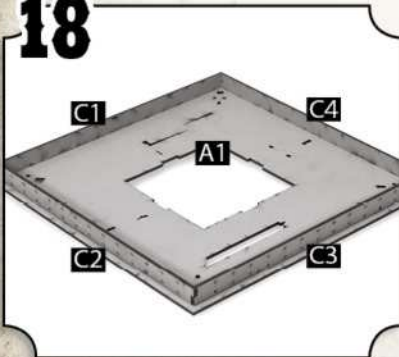

•Connect C1, C2, C3 & C4 to the underside of A1.

19

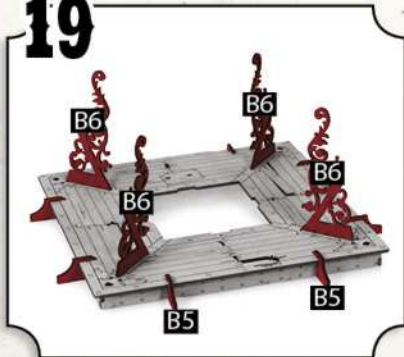

•Connect 8x B5 around the edge of A1.
•Connect 4x B6 to A1.

20

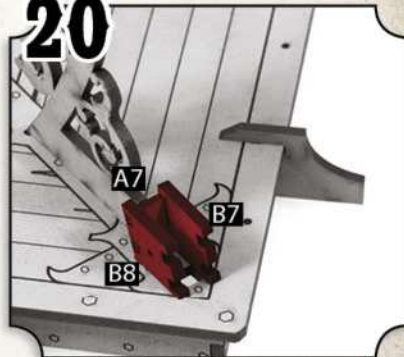

•Spare parts are included to customise your set, (parts A8, A9, A10, A11, A12, A17, A19 & B10).



Parts may need careful removal from the MDF boards with a scalpel, and light sanding of any rough edges. We recommend testing assembling sections before permanently gluing together.

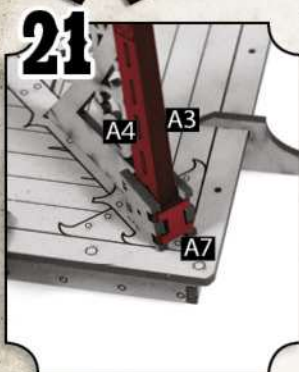

- Slot 8x B9 onto the staircase to form the steps.
- Glue B15 on top.
- Repeat steps 20 & 21 for the remaining three corners.



- Connect the tower to the base (A1) as shown.



- Connect A6 to the top of the tower.
- Ensure that both details labelled with a '!' are on the same side of the tower.

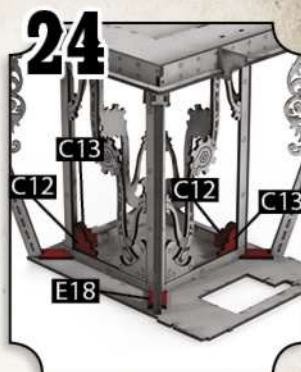

- Connect C12 to C13 and glue in the two corners shown.
- Glue E18 on each corner of the tower as shown. Glue between E18 and support struts.

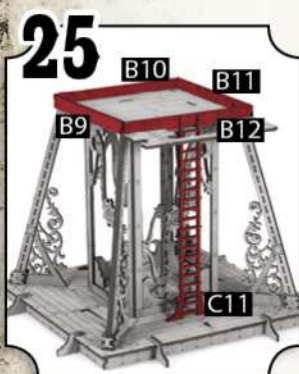

- Attach B9, B10, B11 & B12 to A6.
- Connect C11 to A1

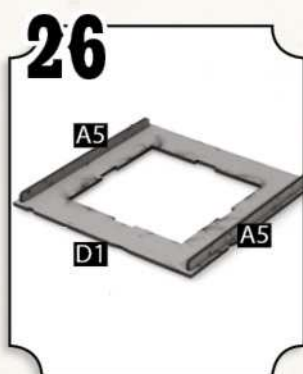

- Connect 2x A5 to D1.

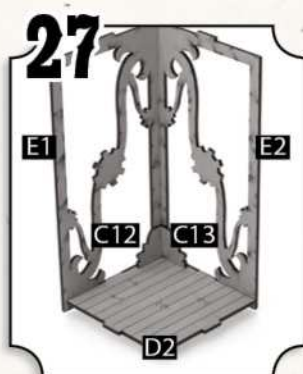

- Connect E1 & E2 to D2.
- Connect C12 to C13 and glue in the corner as shown.

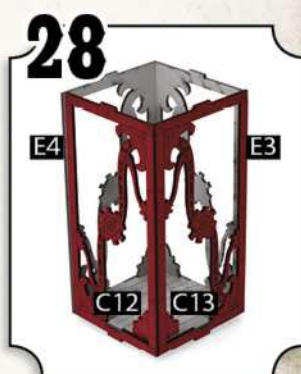

- Connect E3 & E4 to D2.
- Connect C12 to C13 and glue in the corner as shown.

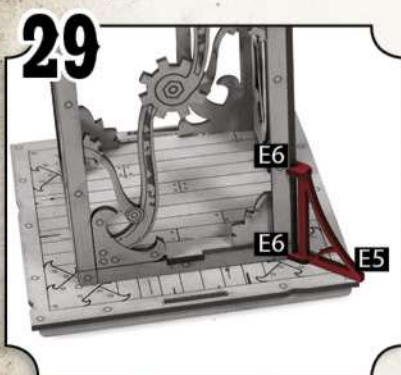

- Combine 2x E6 to E5 and glue in the corner indicated.
- Repeat for the other three corners.

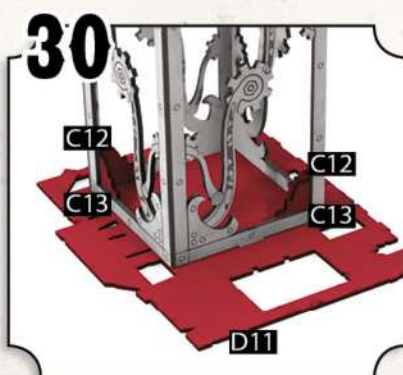

- Connect tower to D11.
- Connect a C12 to C13.
- Connect another C12 to C13 and glue in the two corners shown.

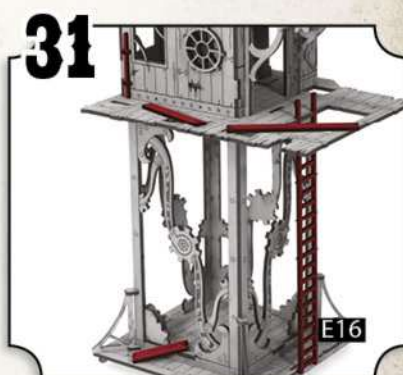

- Connect the ladder (E16).
- Spare parts are included to customise your set, (parts A8, A9, C5, D5, D6, E10 & E11).