

# CONSTITUTION CLASS BATTLESHIP

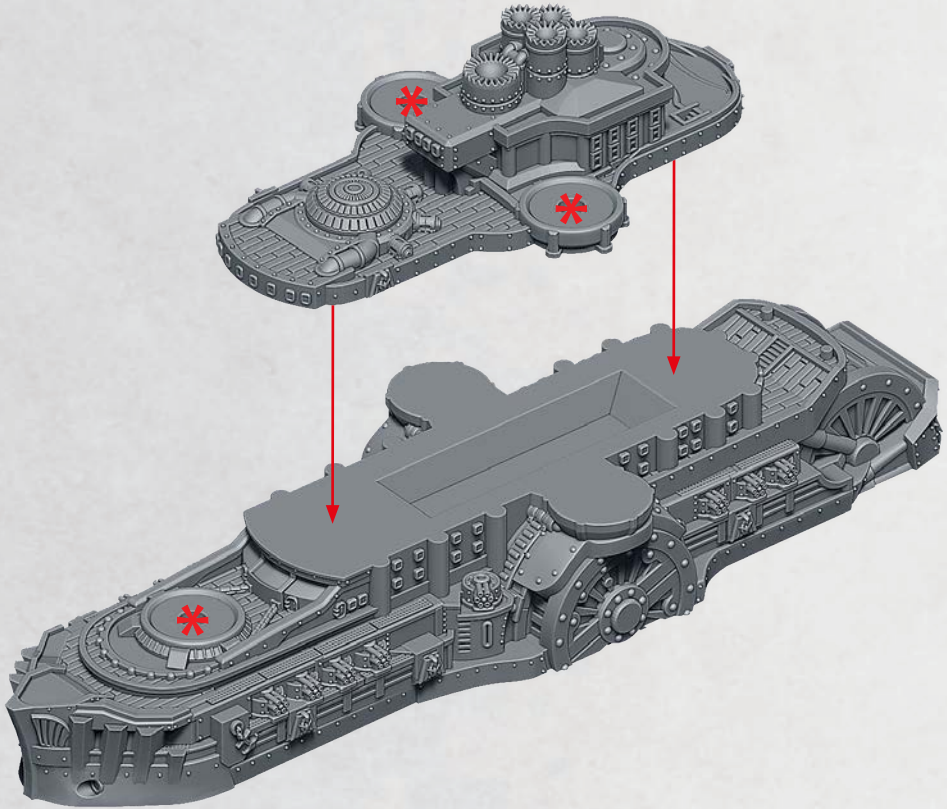

ROCKET  
BATTERY



44-47

HEAVY GUN  
BATTERY



40-43

\* ALL TURRETS ARE INTERCHANGEABLE

# INTREPID CLASS LIGHT CRUISER

PARTS CAN BE FOUND ON THE UNION FRONTLINE SQUADRONS SPRUES

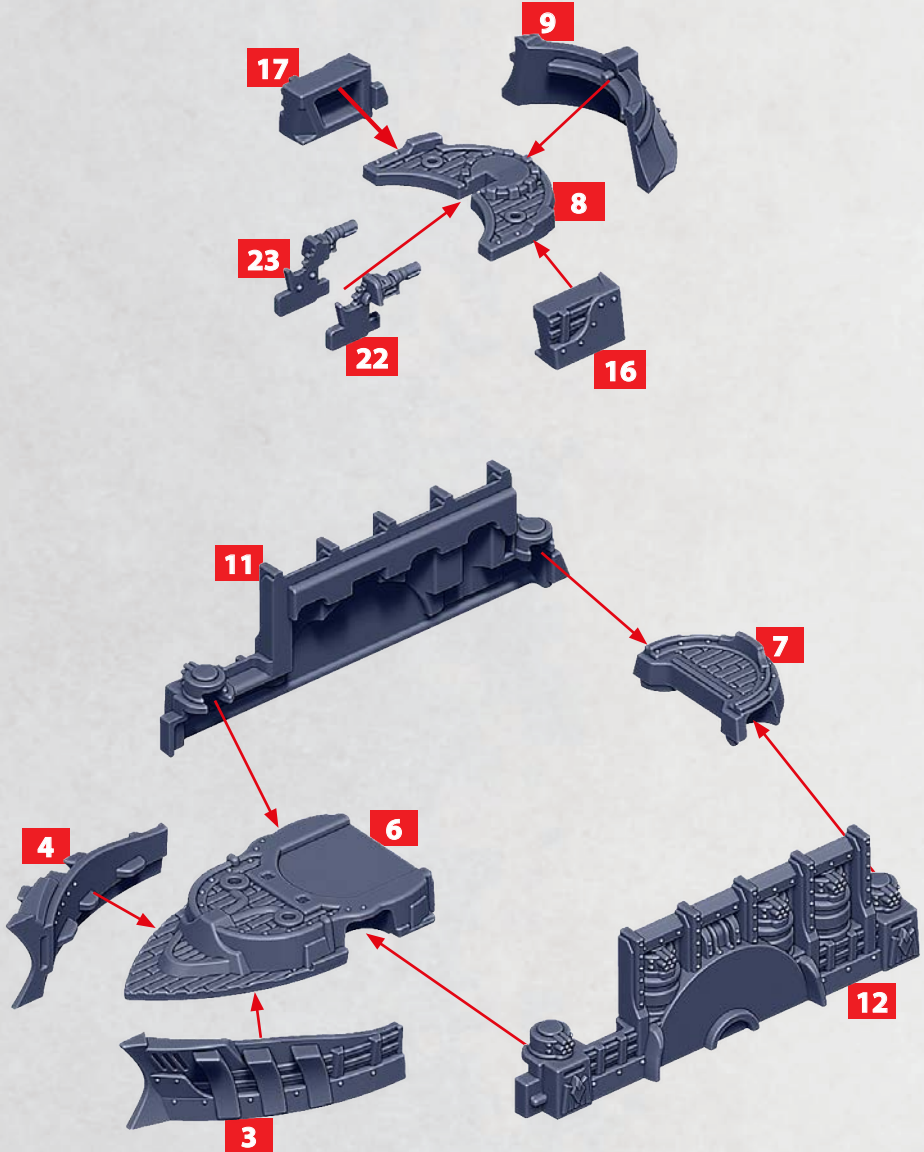

# INTREPID CLASS LIGHT CRUISER

PARTS CAN BE FOUND ON THE UNION FRONTLINE SQUADRONS SPRUES

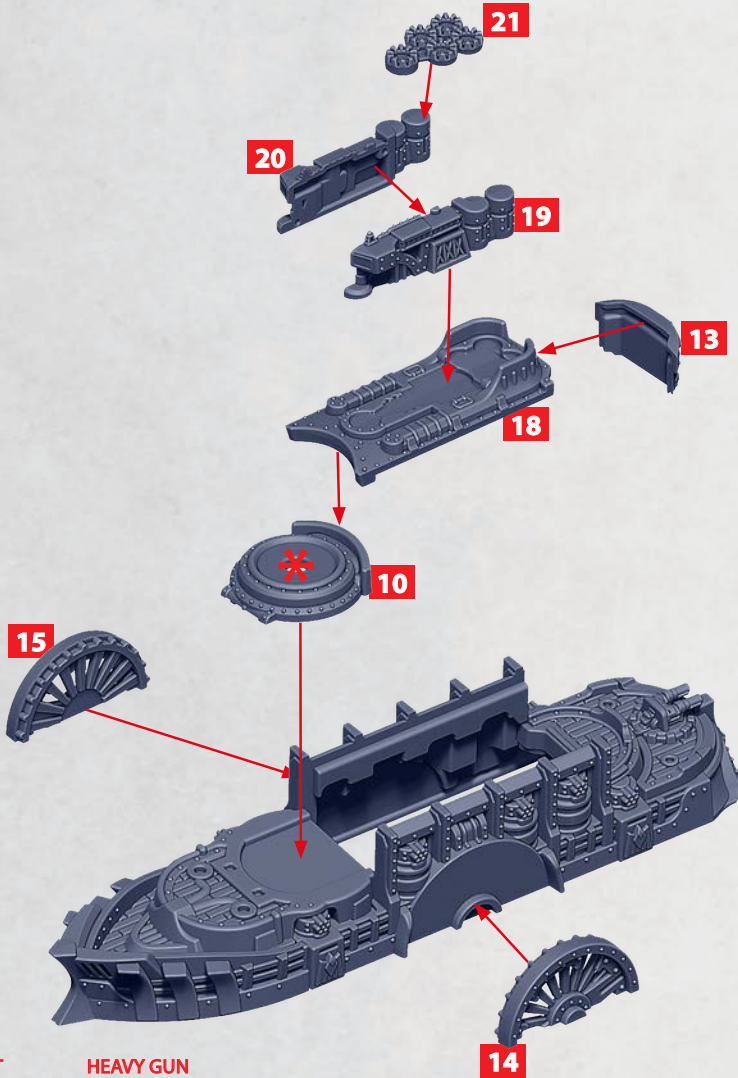

ROCKET  
BATTERY



44-47

HEAVY GUN  
BATTERY



40-43

\* ALL TURRETS ARE INTERCHANGEABLE

# LEXINGTON CLASS LIGHT CRUISER

PARTS CAN BE FOUND ON THE UNION FRONTLINE SQUADRONS SPRUES

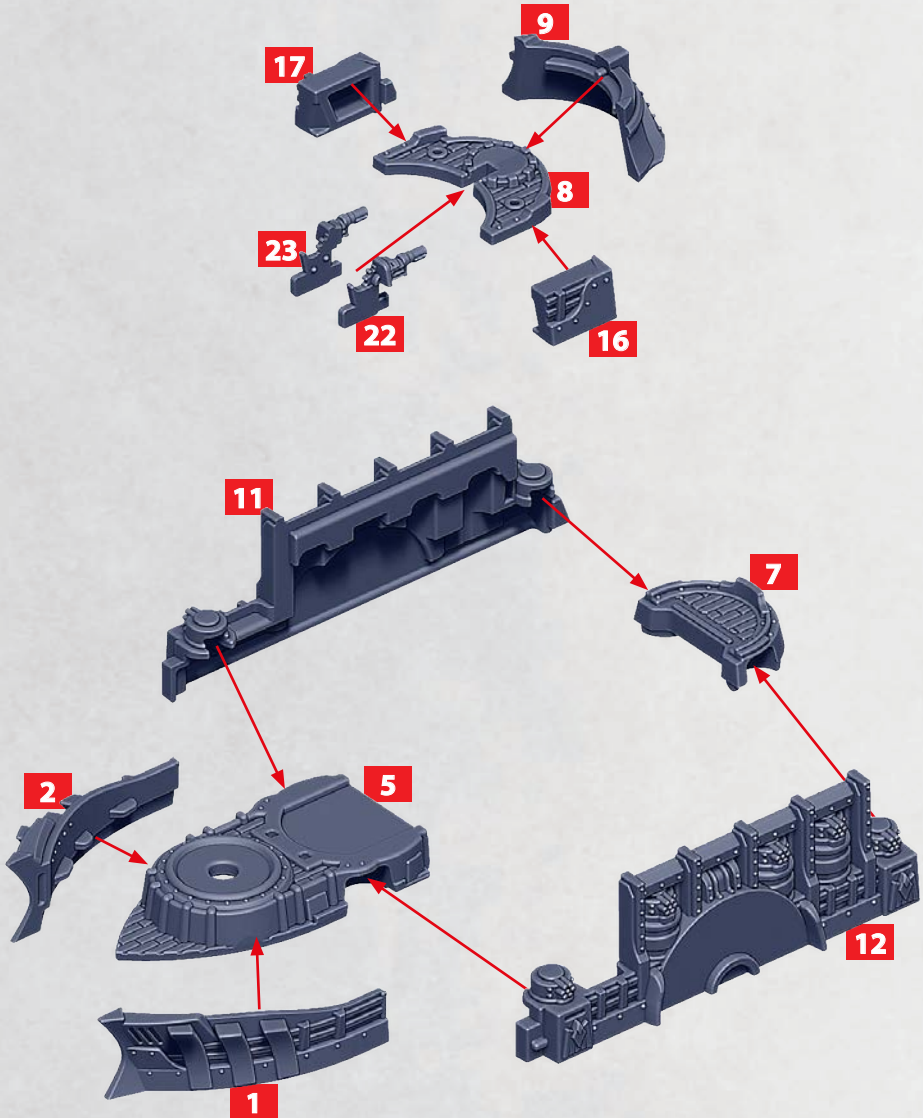

# LEXINGTON CLASS LIGHT CRUISER

PARTS CAN BE FOUND ON THE UNION FRONTLINE SQUADRONS SPRUES

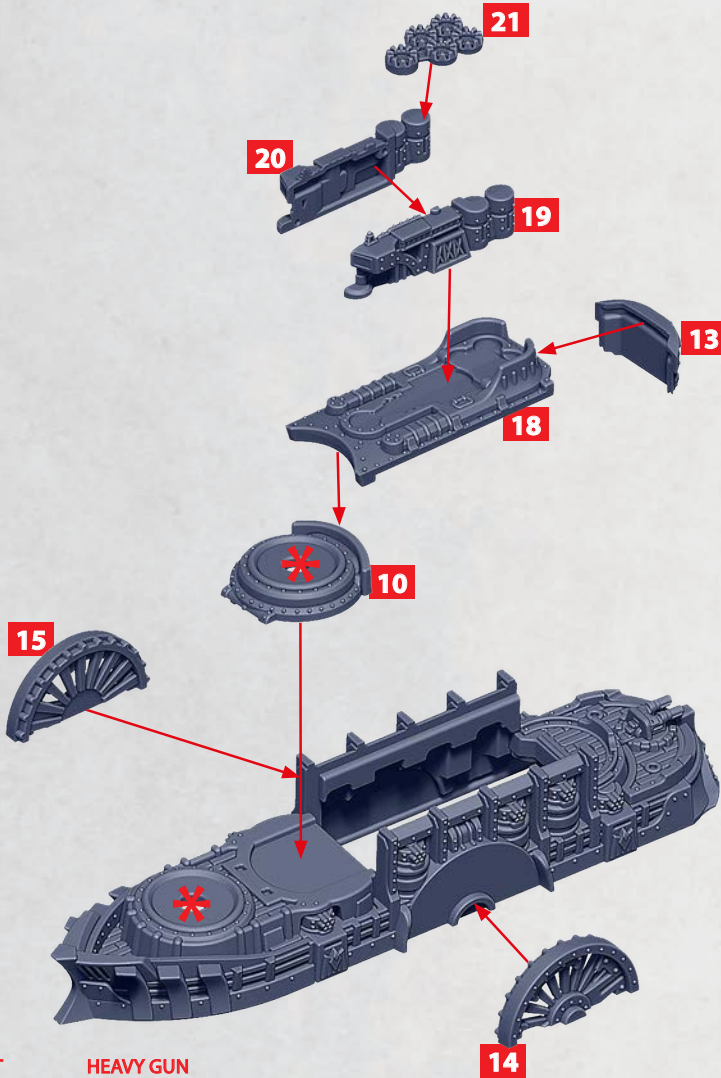

ROCKET  
BATTERY



44-47

HEAVY GUN  
BATTERY



40-43

\* ALL TURRETS ARE INTERCHANGEABLE

# RELIANT CLASS LIGHT CRUISER

PARTS CAN BE FOUND ON THE UNION FRONTLINE SQUADRONS SPRUES

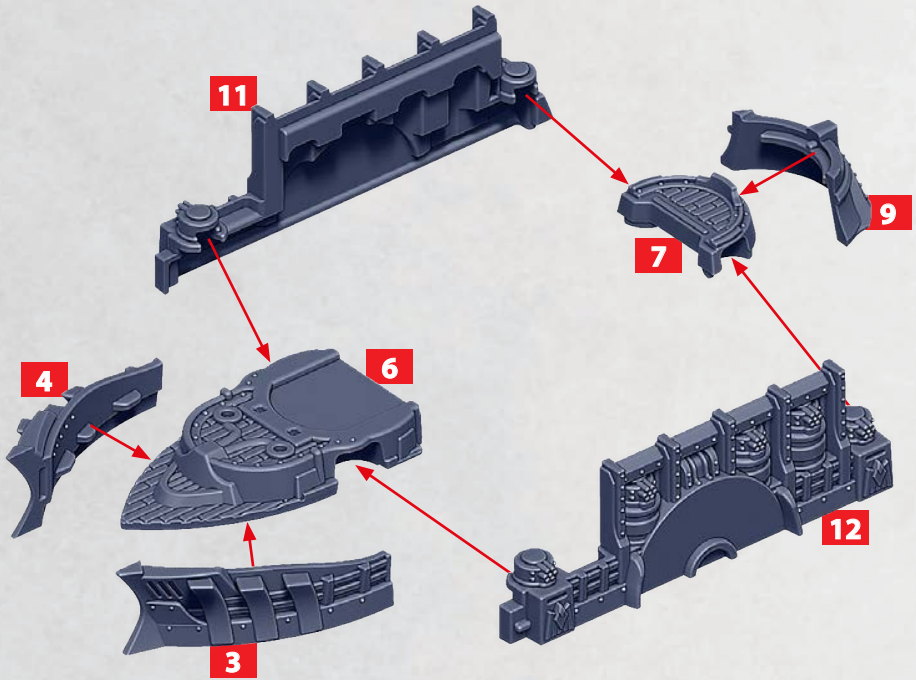

# RELIANT CLASS LIGHT CRUISER

PARTS CAN BE FOUND ON THE UNION FRONTLINE SQUADRONS SPRUES

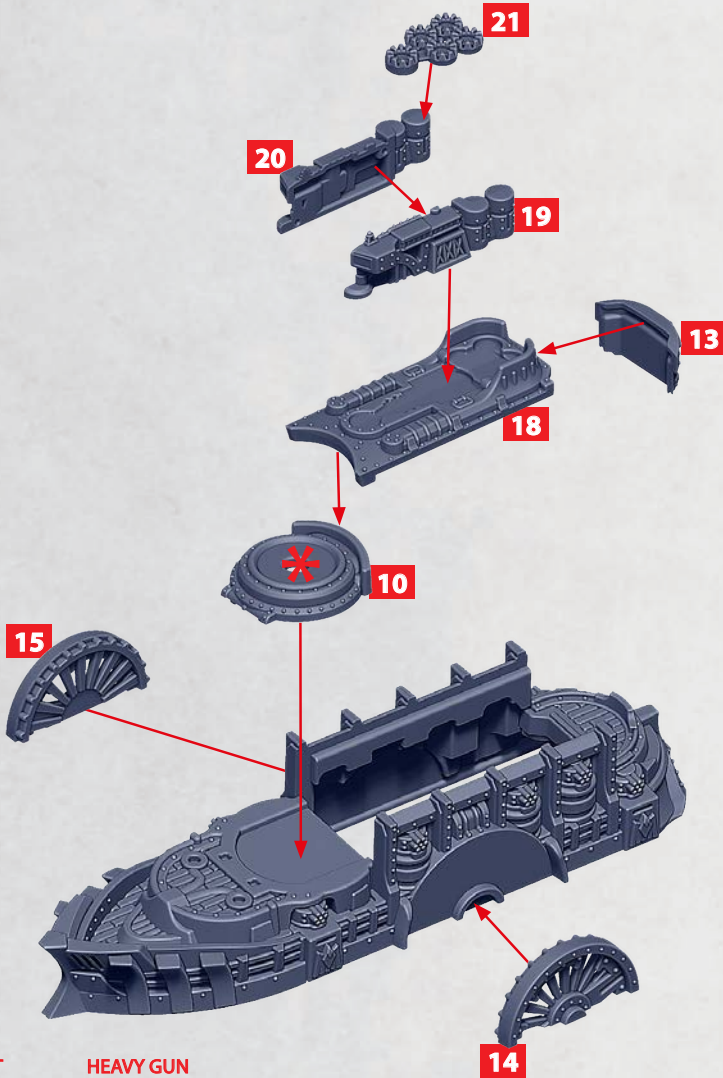

ROCKET  
BATTERY



44-47

HEAVY GUN  
BATTERY



40-43

\* ALL TURRETS ARE INTERCHANGEABLE

# YORKTOWN CLASS LIGHT CRUISER

PARTS CAN BE FOUND ON THE UNION FRONTLINE SQUADRONS SPRUES

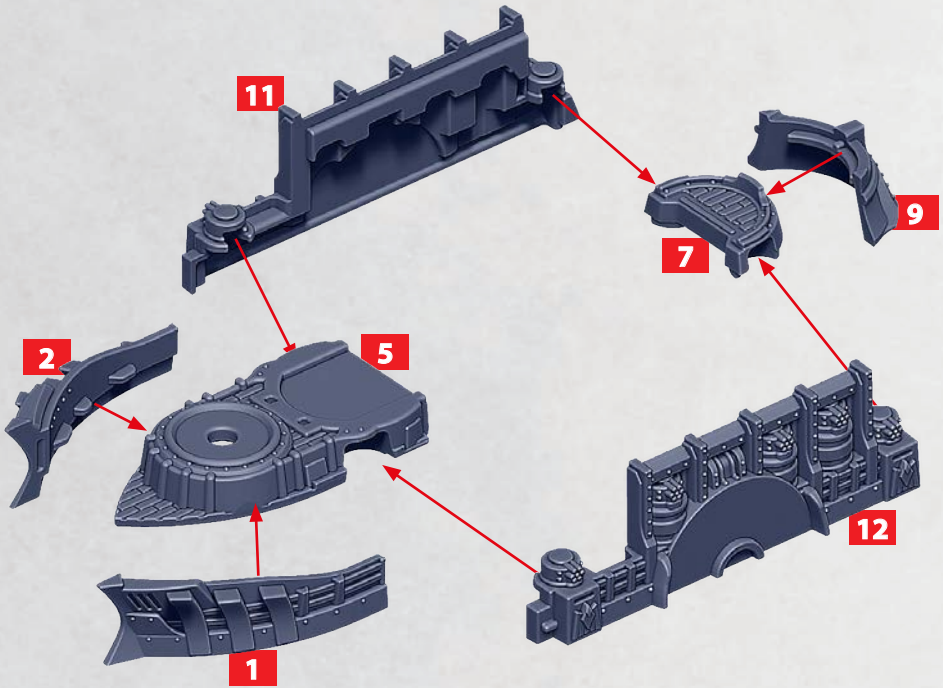



# YORKTOWN CLASS LIGHT CRUISER

PARTS CAN BE FOUND ON THE UNION FRONTLINE SQUADRONS SPRUES

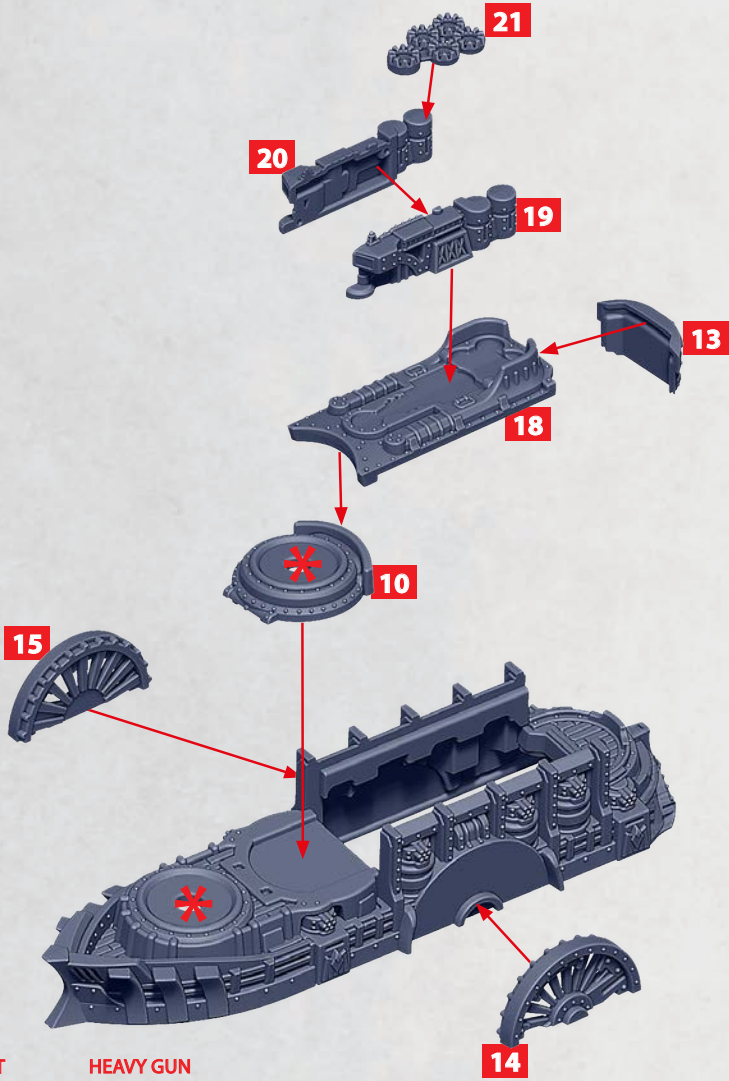

ROCKET  
BATTERY



44-47

HEAVY GUN  
BATTERY



40-43

\* ALL TURRETS ARE INTERCHANGEABLE

# FARRAGUT CLASS FRIGATE

PARTS CAN BE FOUND ON THE UNION FRONTLINE SQUADRONS SPRUES

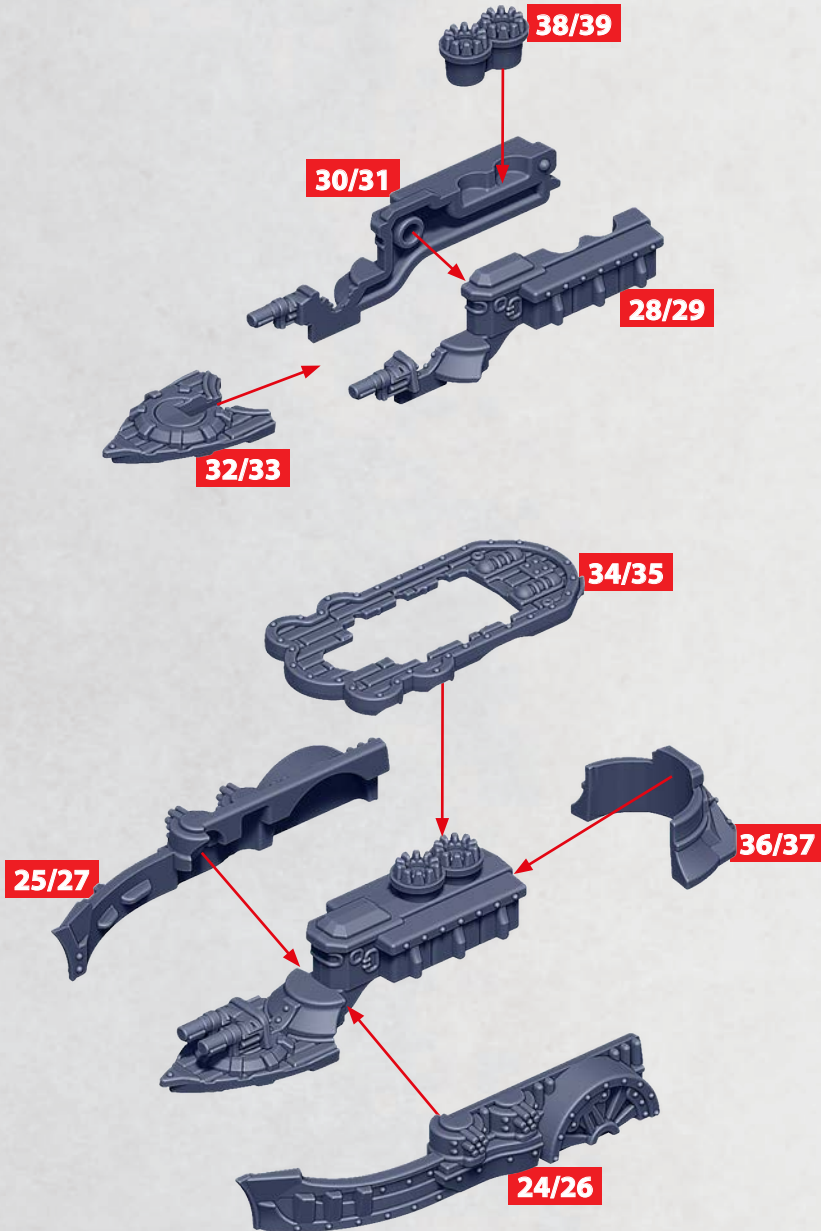

# CALIFORNIA CLASS CRUISER

PARTS CAN BE FOUND ON THE UNION SUPPORT SQUADRONS SPRUES

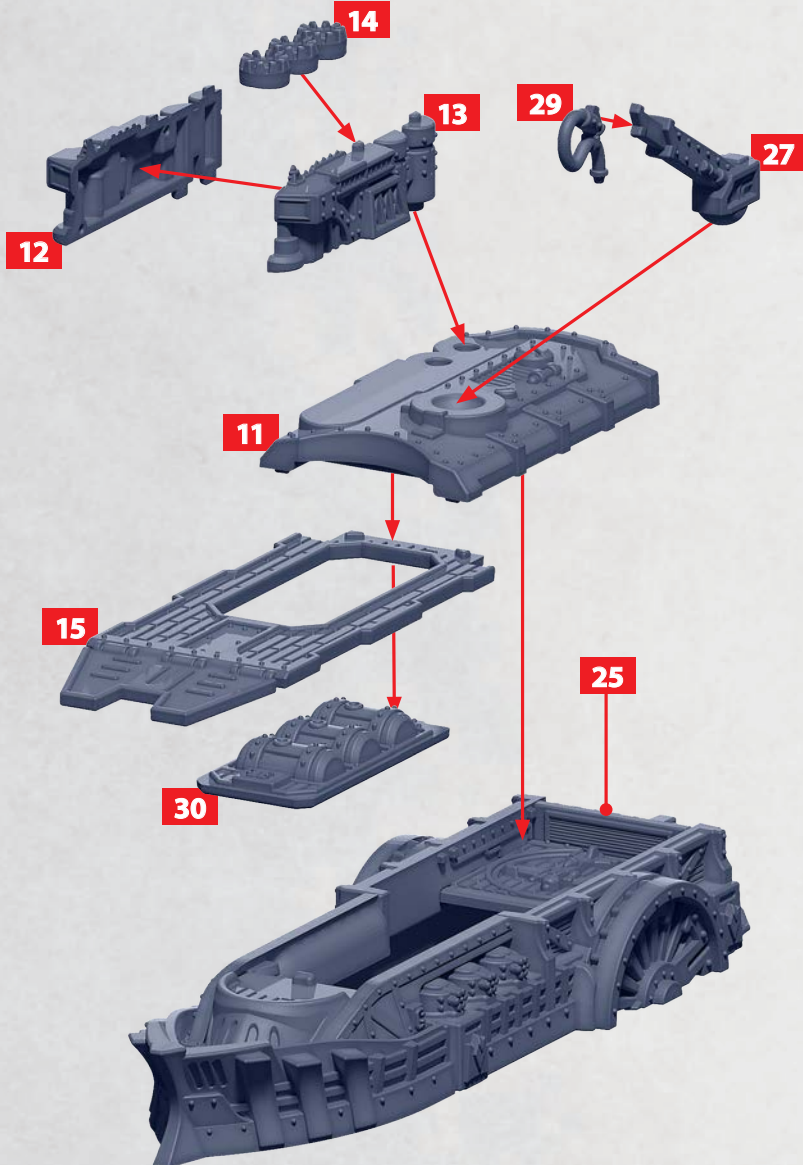

# MONTGOMERY CLASS CRUISER

PARTS CAN BE FOUND ON THE UNION SUPPORT SQUADRONS SPRUES

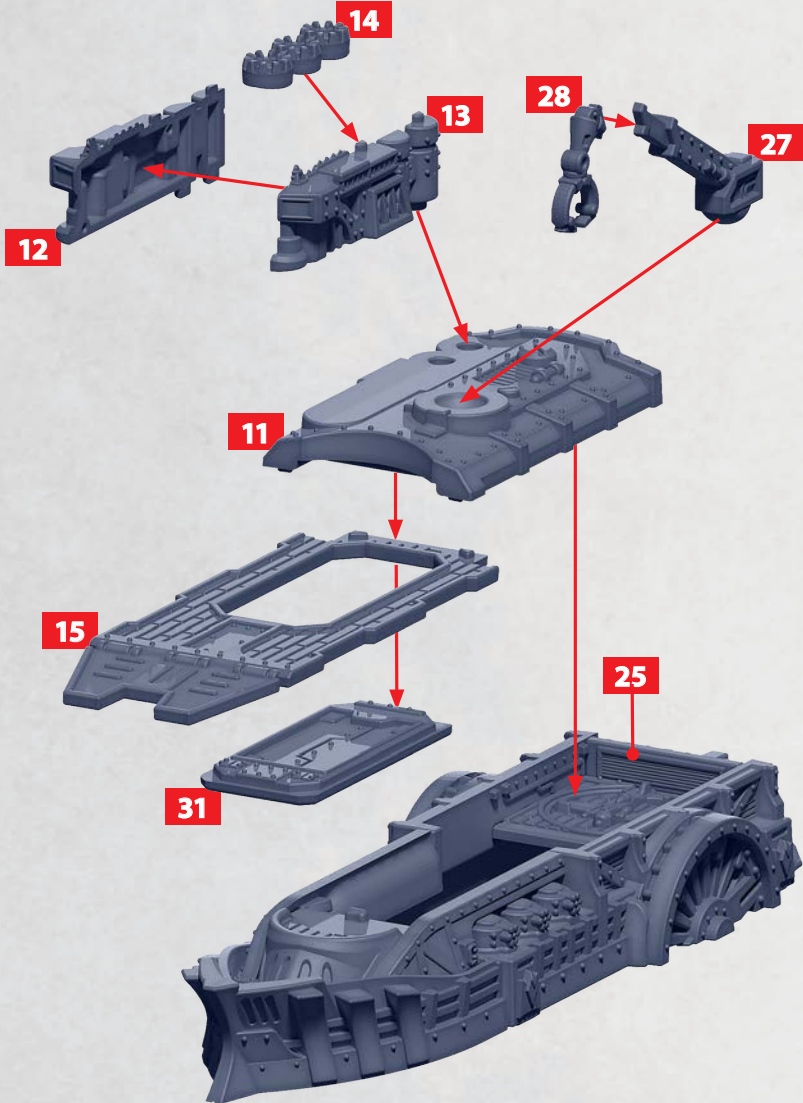

# ROANOKE CLASS CRUISER

PARTS CAN BE FOUND ON THE UNION SUPPORT SQUADRONS SPRUES

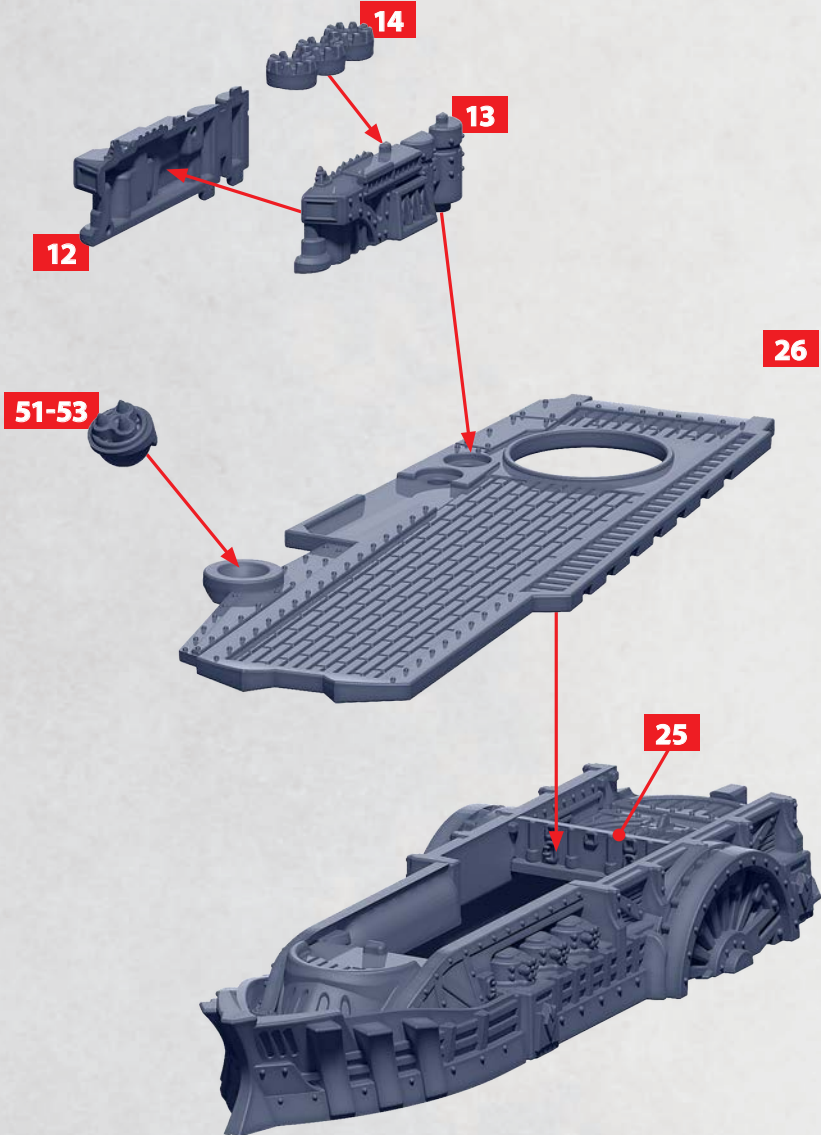

# WASHINGTON CLASS CRUISER

PARTS CAN BE FOUND ON THE UNION SUPPORT SQUADRONS SPRUES

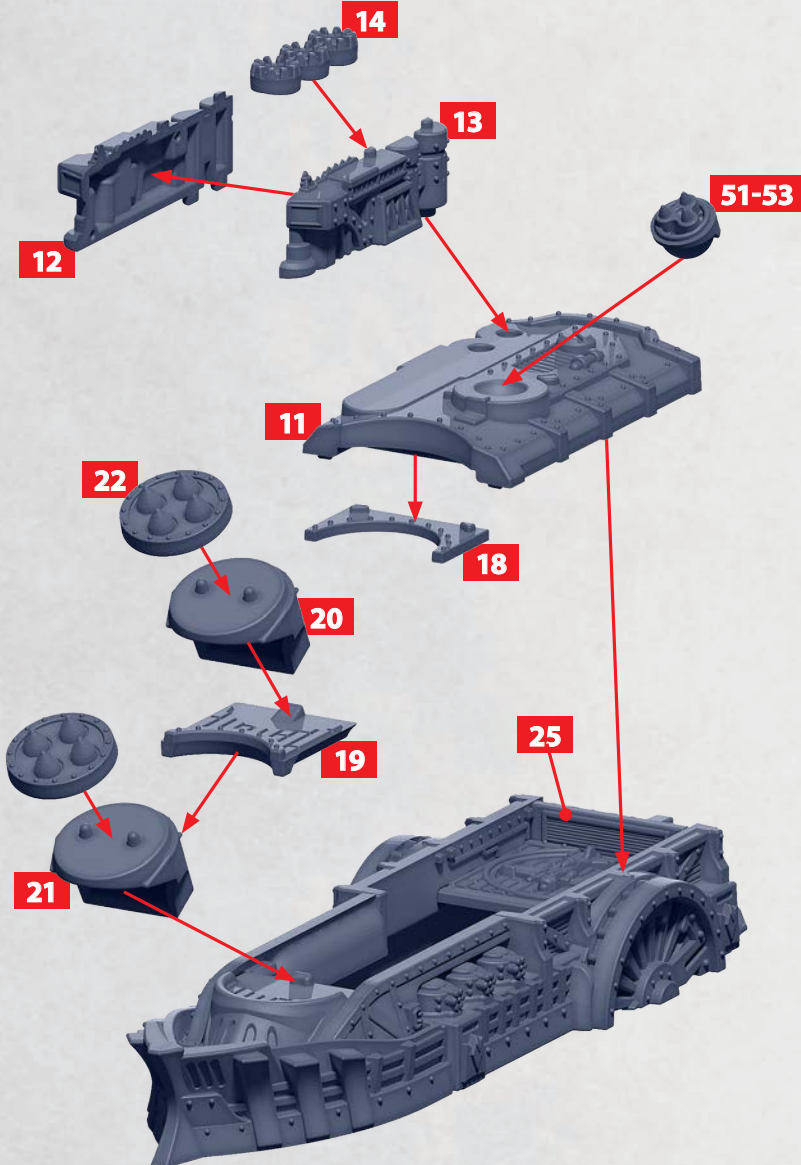

# RC-52 PATRIOT AUTOMATA

PARTS CAN BE FOUND ON THE **UNION SUPPORT SQUADRONS** SPRUES

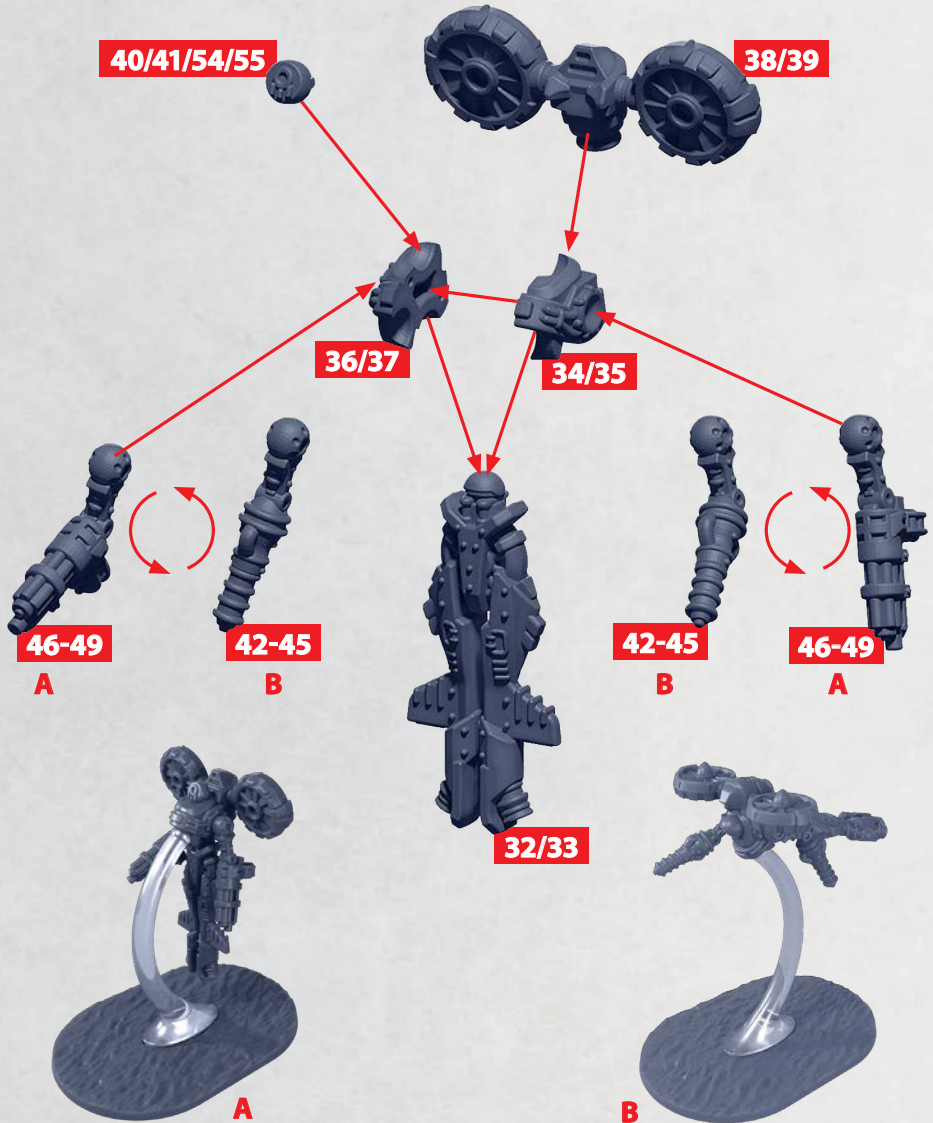

**AUTOMATA MUST BE ASSEMBLED WITH THE SAME WEAPON OPTION FOR BOTH ARMS, I.E. DUAL GATLING CANNONS (A) OR DUAL NAVAL ELECTROCANNONS (B). AUTOMATA CAN ALSO BE POSITIONED ON THE FLIGHT STAND AS DESIRED (SEE ABOVE).**