

BATTLESHIP HULL FOR ELECTOR, HEIDELBERG, KAISER, SMS TIRPITZ SMS BRANDENBURG AND SMS HOLTZENDORFF

PARTS CAN BE FOUND IN RESIN

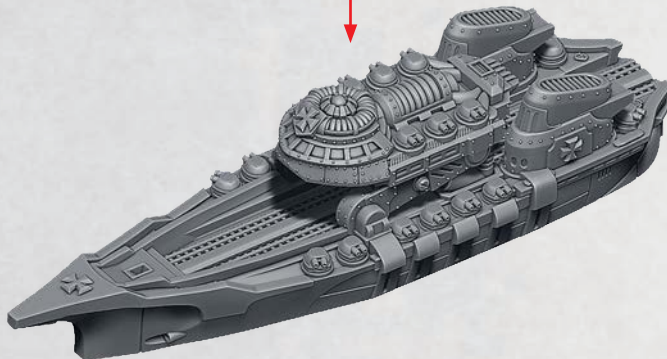
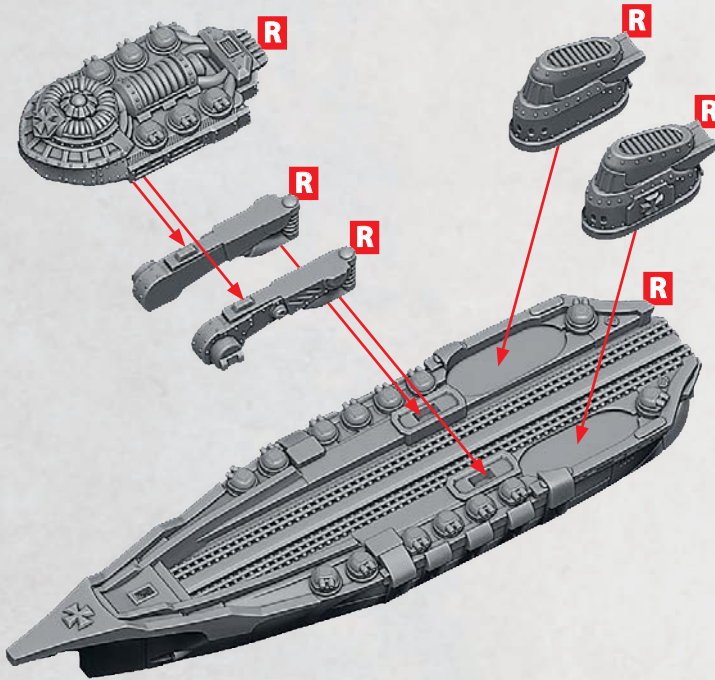

GUSTAV HEAVY BOMBARD AND BERTHA HEAVY BOMBARD GUNS

PARTS CAN BE FOUND ON THE IMPERIUM CRUISERS & FRIGATES SPRUES

OPTION 1

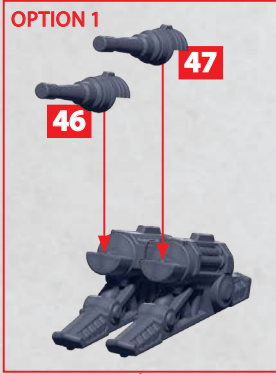

GUSTAV HEAVY BOMBARD

OPTION 2

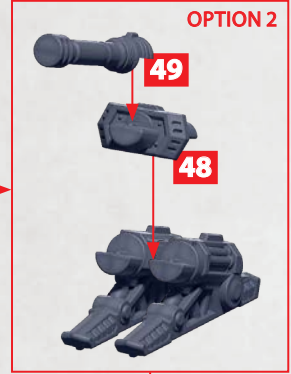

BERTHA HEAVY BOMBARD



NOTE: BE SURE TO EXPLORE
ALL BUILD OPTIONS BEFORE
ASSEMBLY OF THESE PARTS

GUN CARRIAGE

PARTS CAN BE FOUND ON THE IMPERIUM CRUISERS & FRIGATES SPRUES

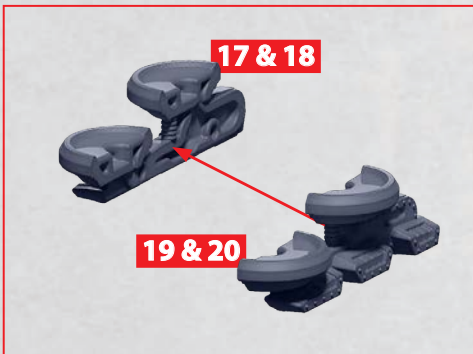

CURRENT VIEW APPEARS AT THE
BOW OF THE SHIP – ROTATES 180°
WHEN APPEARING AT SHIP'S AFT

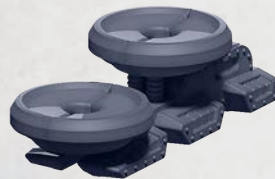

ELECTOR

PARTS CAN BE FOUND ON THE **IMPERIUM CRUISERS & FRIGATES SPRUES AND RESIN**

GUSTAV HEAVY BOMBARD SHOWN.
CAN ALSO BE ASSEMBLED WITH
BERTHA HEAVY BOMBARD
(SEE PAGE 2 FOR PARTS)

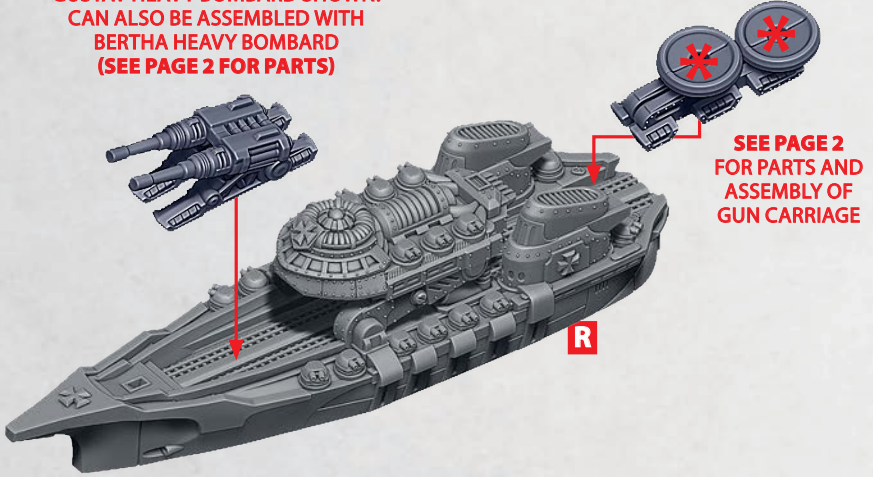

SEE PAGE 2
FOR PARTS AND
ASSEMBLY OF
GUN CARRIAGE

HEIDELBERG

PARTS CAN BE FOUND ON THE **IMPERIUM CRUISERS & FRIGATES SPRUES AND RESIN**

SEE PAGE 2
FOR PARTS AND
ASSEMBLY OF
GUN CARRIAGE

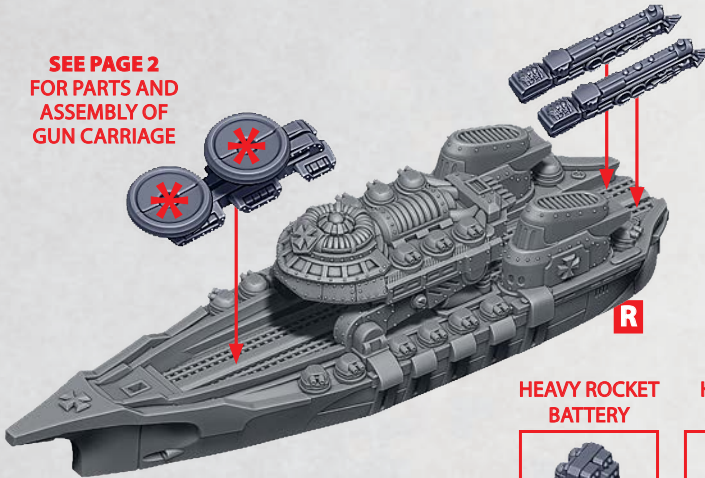

HEAVY ROCKET
BATTERY



7-8

HEAVY ARC GUN
BATTERY



25-28

* ALL TURRETS ARE INTERCHANGEABLE

KAISER

PARTS CAN BE FOUND ON THE **IMPERIUM CRUISERS & FRIGATES SPRUES AND RESIN**

SEE PAGE 2
FOR PARTS AND
ASSEMBLY OF
GUN CARRIAGE

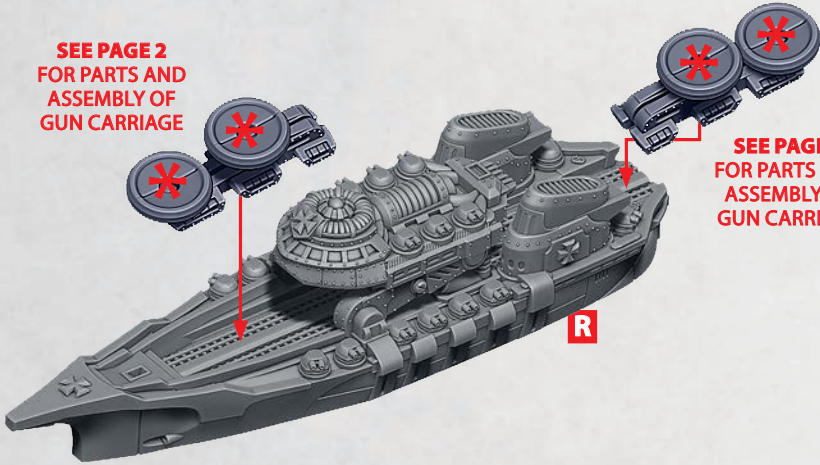

SEE PAGE 2
FOR PARTS AND
ASSEMBLY OF
GUN CARRIAGE

SMS TIRPITZ

PARTS CAN BE FOUND ON THE **IMPERIUM CRUISERS & FRIGATES SPRUES AND RESIN**

SEE PAGE 2
FOR PARTS AND
ASSEMBLY OF
GUN CARRIAGE

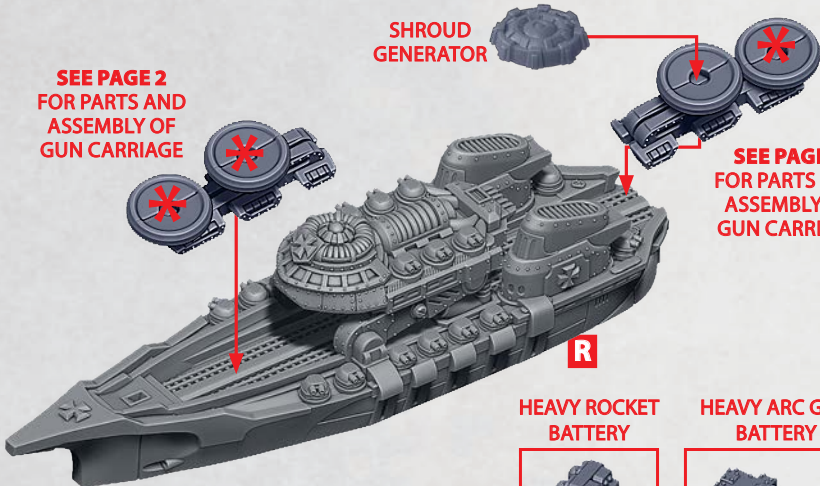

SHROUD
GENERATOR

SEE PAGE 2
FOR PARTS AND
ASSEMBLY OF
GUN CARRIAGE

HEAVY ROCKET
BATTERY



7-10

HEAVY ARC GUN
BATTERY



25-28

* ALL TURRETS ARE INTERCHANGEABLE

SMS BRANDENBURG

PARTS CAN BE FOUND ON THE **IMPERIUM CRUISERS & FRIGATES SPRUES AND RESIN**

GUSTAV HEAVY BOMBARD SHOWN.
CAN ALSO BE ASSEMBLED WITH
BERTHA HEAVY BOMBARD
(SEE PAGE 2 FOR PARTS)

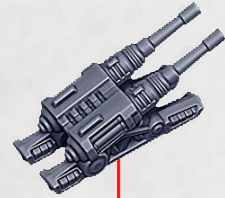
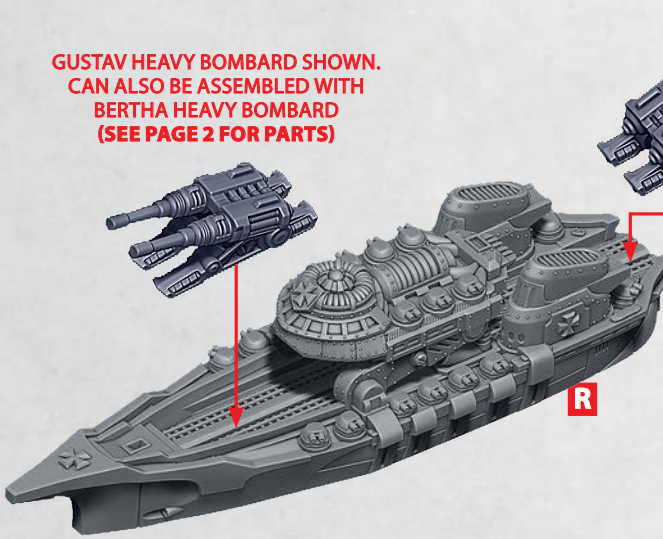

GUSTAV HEAVY
BOMBARD SHOWN.
CAN ALSO BE
ASSEMBLED WITH
BERTHA HEAVY
BOMBARD
(SEE PAGE 2
FOR PARTS)

HOLTZENDORFF PATTERN

PARTS CAN BE FOUND ON THE **IMPERIUM CRUISERS & FRIGATES SPRUES AND RESIN**

GUSTAV HEAVY BOMBARD SHOWN.
CAN ALSO BE ASSEMBLED WITH
BERTHA HEAVY BOMBARD
(SEE PAGE 2 FOR PARTS)

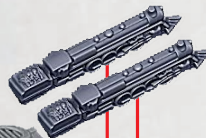
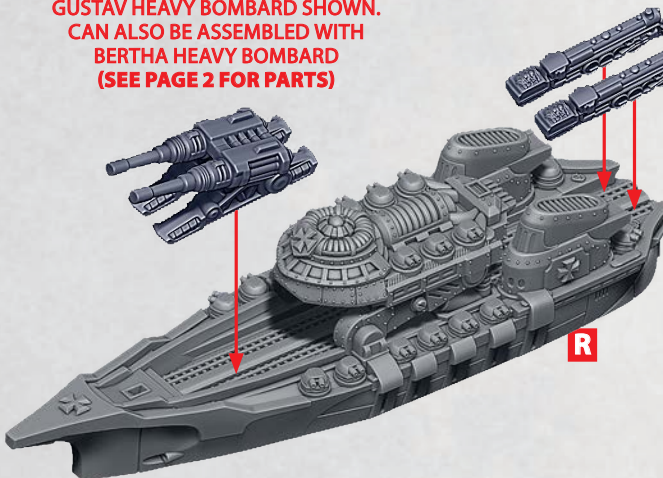

CRUISER HULL FOR BLUCHER, AUGUSTUS, SHAUMBURG, REITER, KONRAD AND VOLSUNG

PARTS CAN BE FOUND ON THE IMPERIUM CRUISERS & FRIGATES
AND IMPERIUM SUPPORT SQUADRONS SPRUES (BLACK NUMBERS)

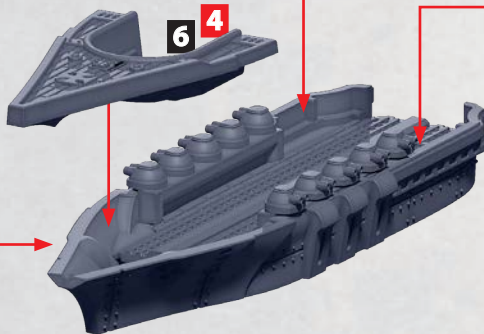
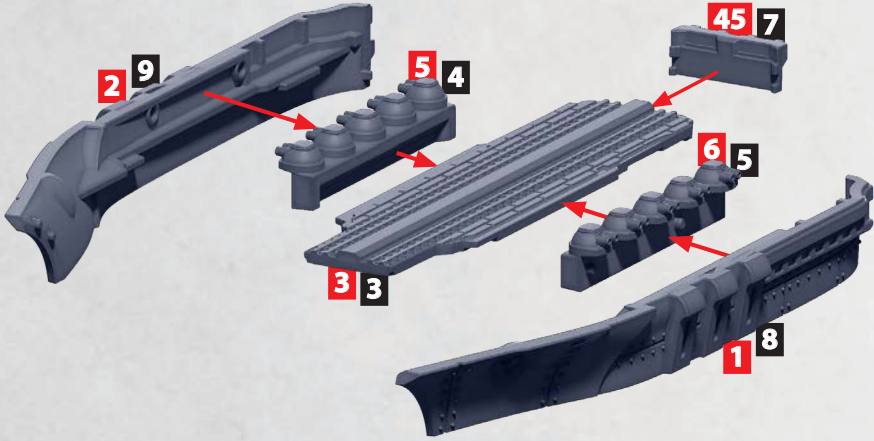

CRUISER BRIDGE FOR BLUCHER, AUGUSTUS OR SHAUMBURG

PARTS CAN BE FOUND ON THE IMPERIUM CRUISERS & FRIGATES SPRUES

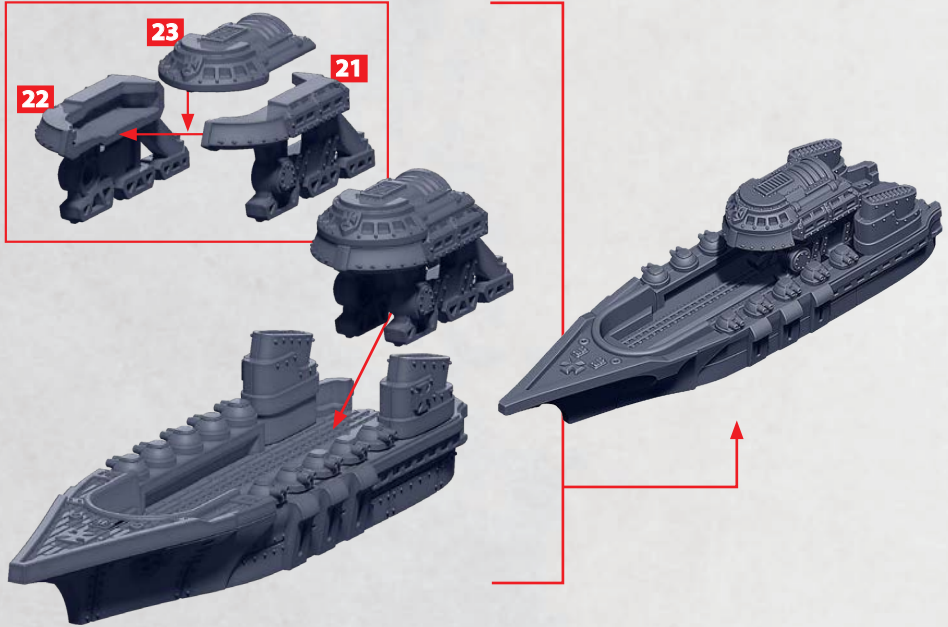

BLUCHER CRUISER

PARTS CAN BE FOUND ON THE IMPERIUM CRUISERS & FRIGATES SPRUES

SEE PAGE 2 FOR
PARTS AND ASSEMBLY
OF GUN CARRIAGE

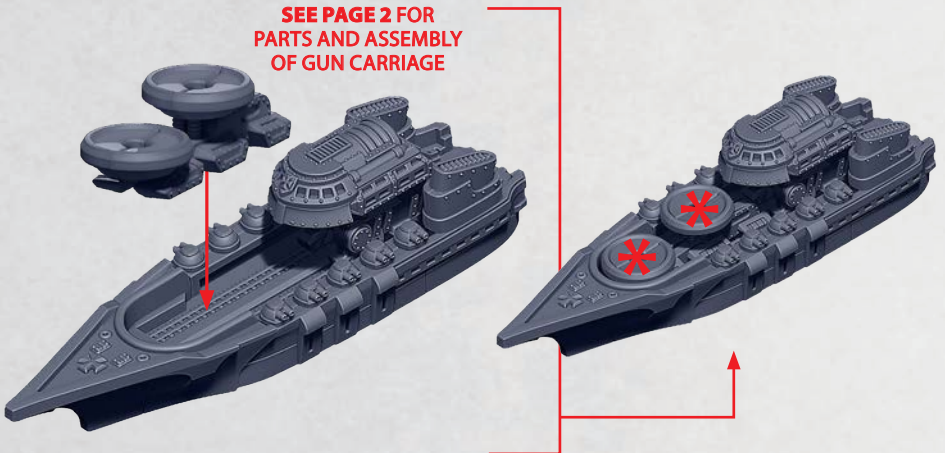

AUGUSTUS BOMBARDMENT CRUISER

PARTS CAN BE FOUND ON THE IMPERIUM CRUISERS & FRIGATES SPRUES

GUSTAV HEAVY BOMBARD SHOWN. CAN
ALSO BE ASSEMBLED WITH BERTHA HEAVY
BOMBARD (SEE PAGE 2 FOR PARTS)

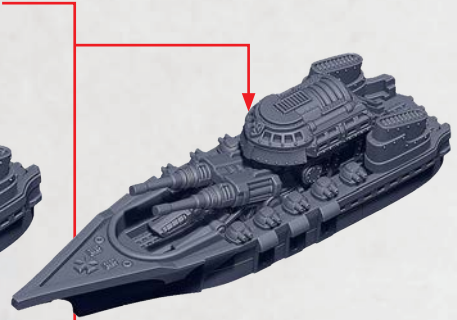
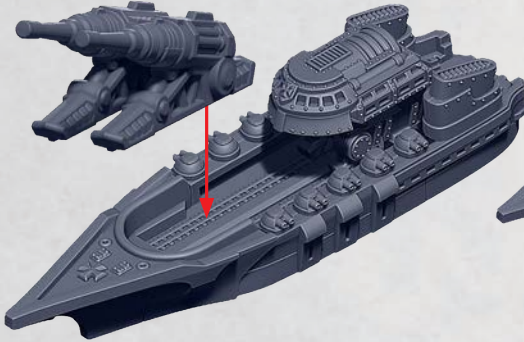

HEAVY ROCKET
BATTERY



7-10

HEAVY ARC GUN
BATTERY



25-28

* ALL TURRETS ARE INTERCHANGEABLE

SCHAUMBURG LOGISTICS CRUISER

PARTS CAN BE FOUND ON THE IMPERIUM CRUISERS & FRIGATES SPRUES

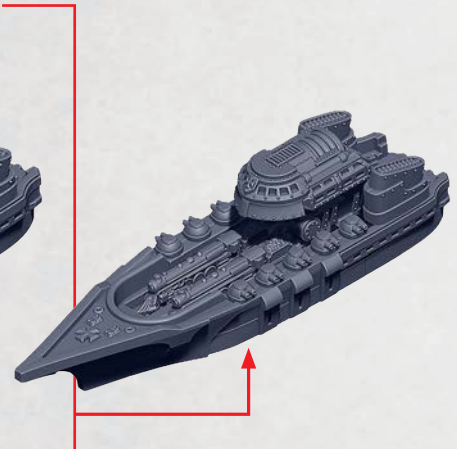
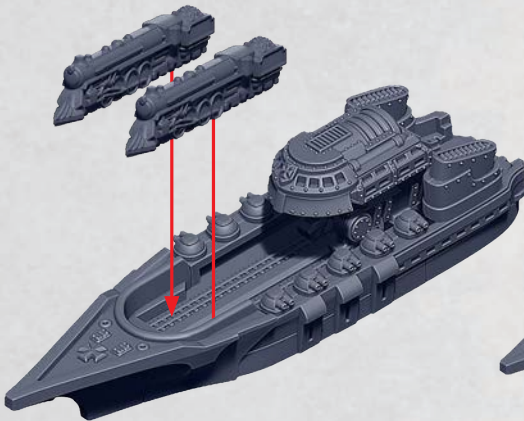

REITER CLASS VEIRLING CRUISER

PARTS CAN BE FOUND ON THE IMPERIUM SUPPORT SQUADRONS SPRUES

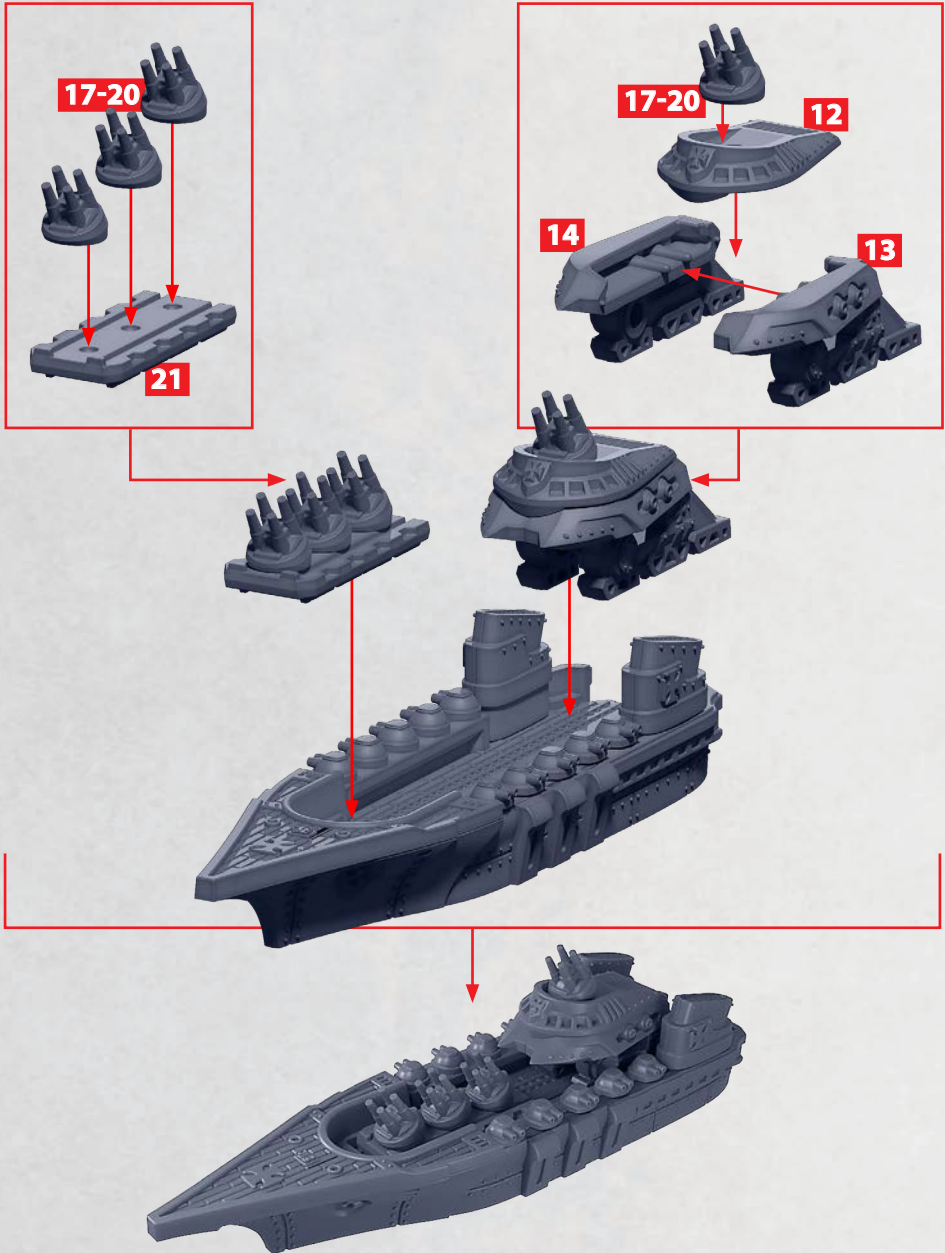

KONRAD CLASS SUPPORT CARRIER

PARTS CAN BE FOUND ON THE IMPERIUM SUPPORT SQUADRONS SPRUES

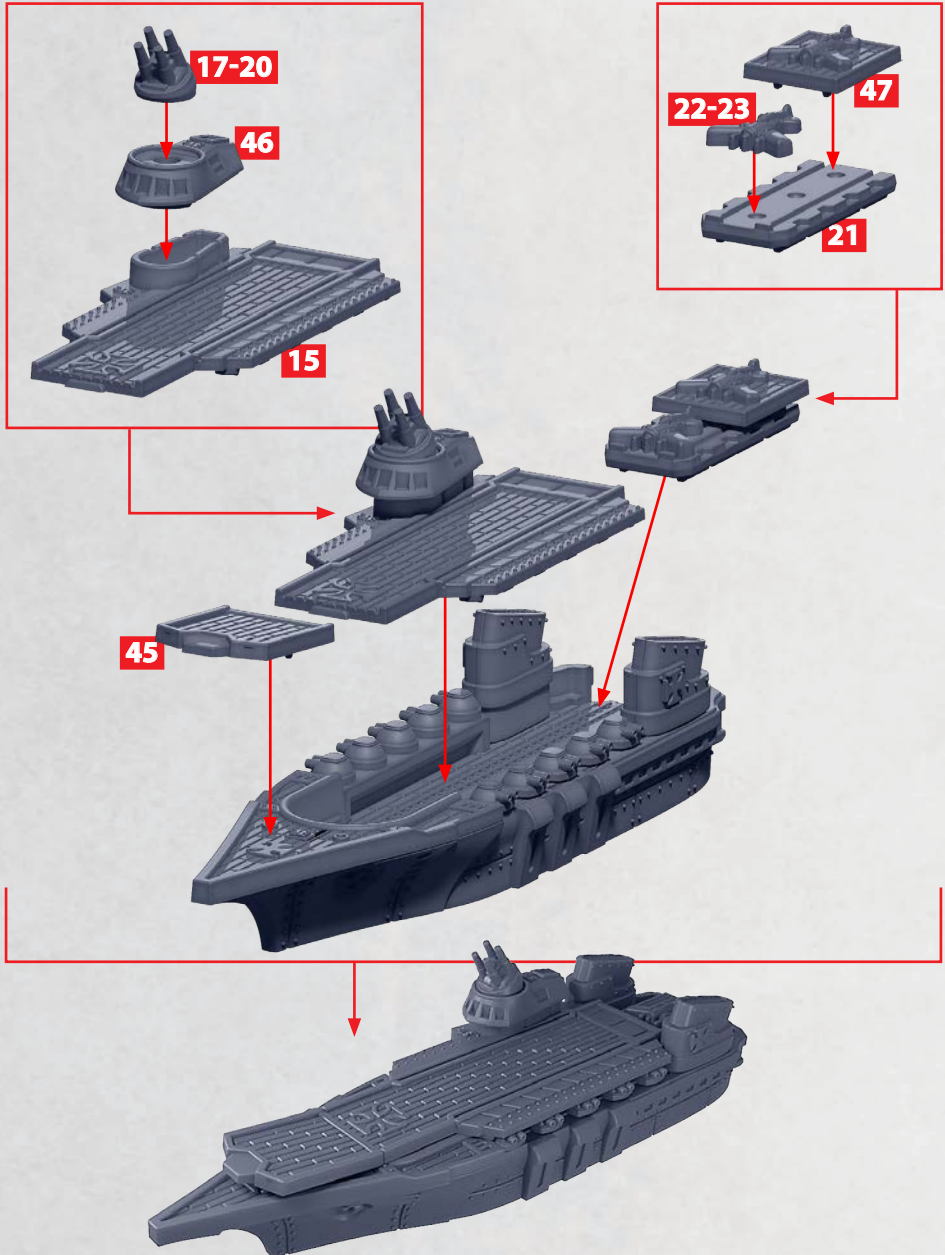

VOLSUNG CLASS CRUISER

PARTS CAN BE FOUND ON THE IMPERIUM SUPPORT SQUADRONS SPRUES

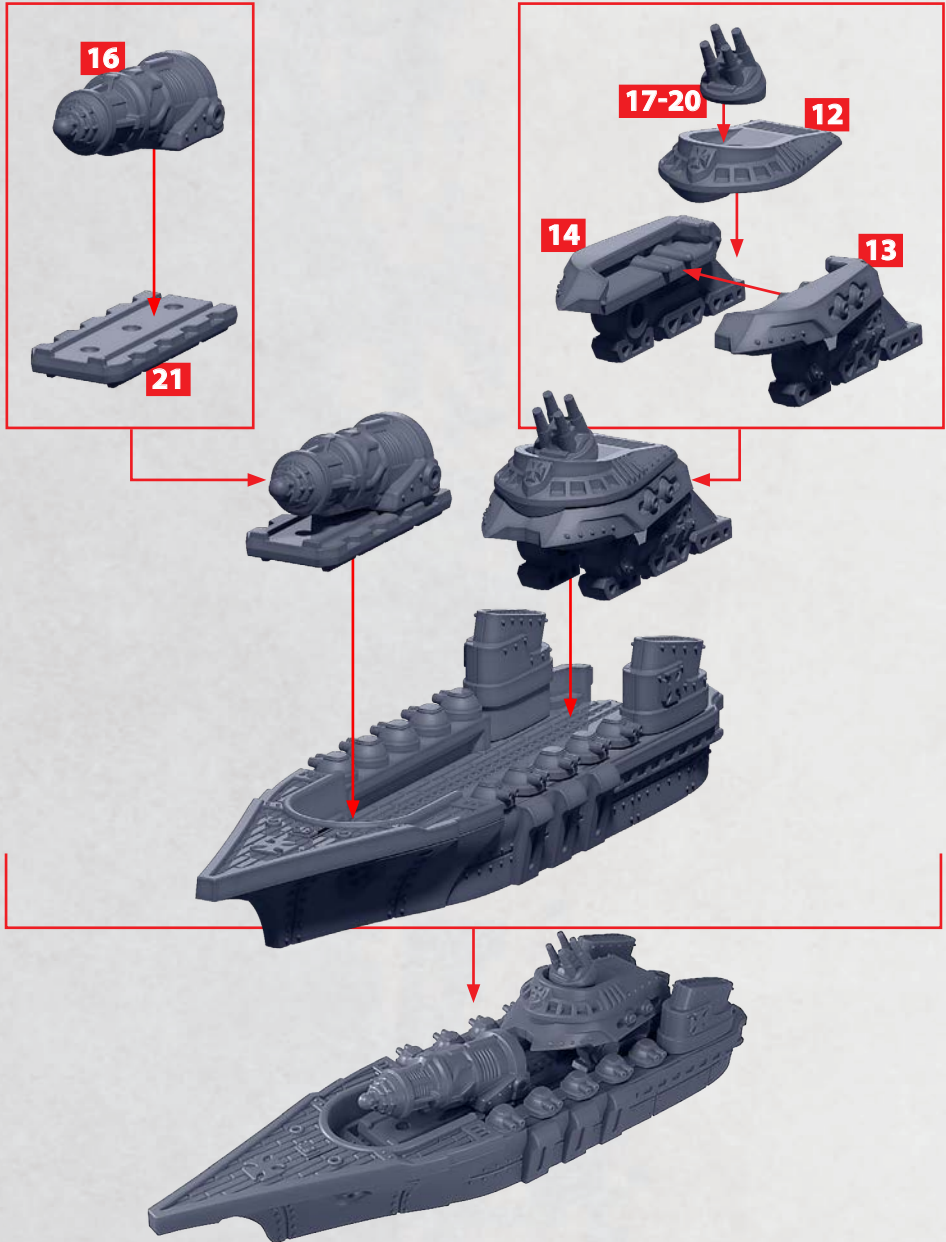

SIGIMER OR TOTEN CLASS DESTROYER

PARTS CAN BE FOUND ON THE IMPERIUM SUPPORT SQUADRONS SPRUES

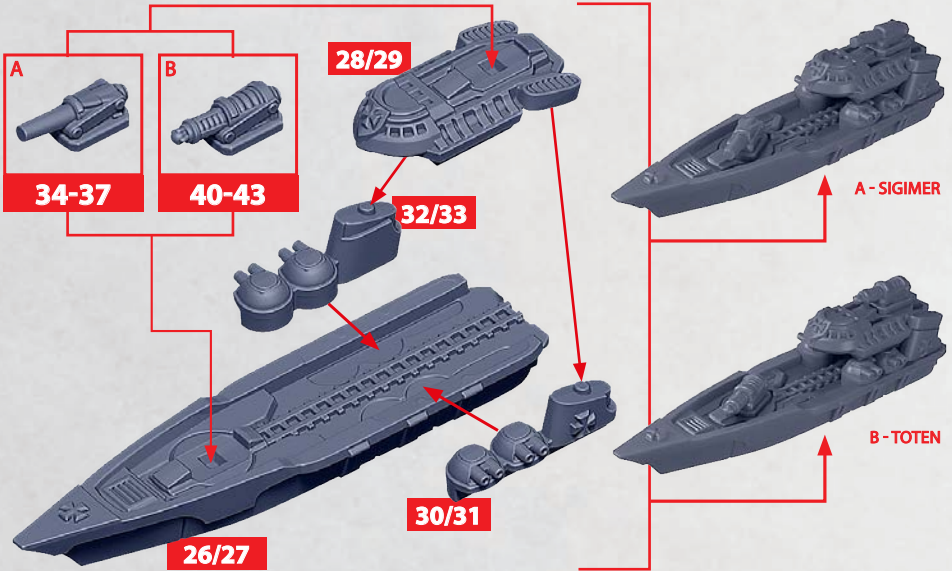

ARMINIUS FRIGATE

PARTS CAN BE FOUND ON THE IMPERIUM CRUISERS & FRIGATES SPRUES

