

# HULL ASSEMBLY FOR EXCELSIOR, VENTURE, CUSTODIAN STEWARD, CONSTELLATION, REPUBLIC, TICONDEROGA, RANGER

PARTS CAN BE FOUND ON THE **UNION AERIAL SQUADRONS** SPRUES

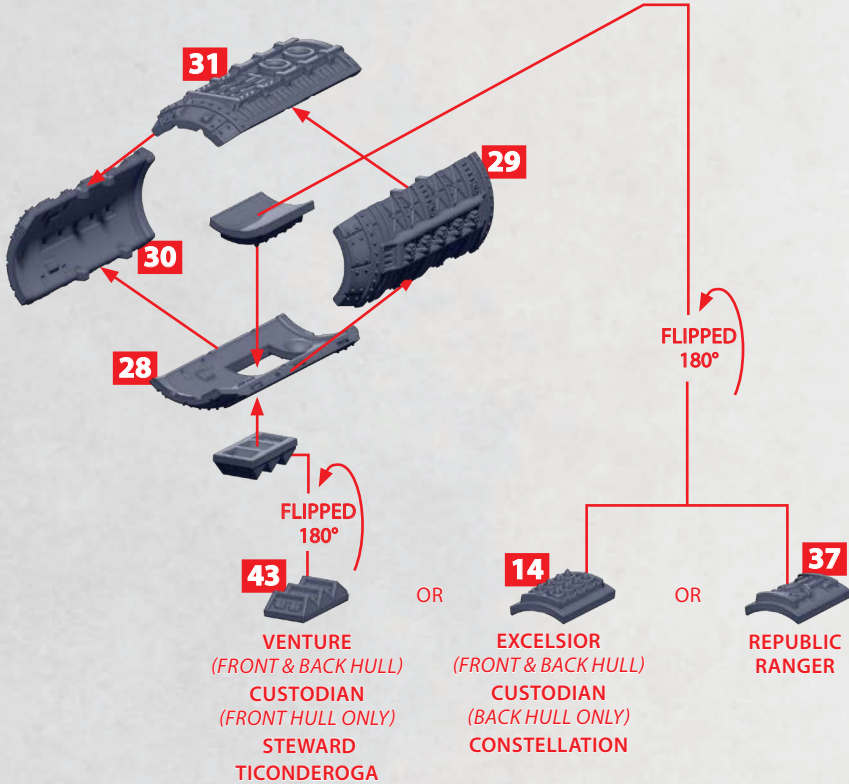

**X2 REQUIRED FOR  
EXCELSIOR, VENTURE AND CUSTODIAN**

**!! IMPORTANT !!**  
ENSURE YOU HAVE THE RIGHT UNDERSIDE PANEL  
FOR YOUR CHOSEN BUILD – PART 14, 37 OR 43  
(SEE ABOVE FOR DETAILS)

# TAIL ASSEMBLY FOR EXCELSIOR, VENTURE, CUSTODIAN STEWARD, CONSTELLATION, REPUBLIC, TICONDEROGA, RANGER

PARTS CAN BE FOUND ON THE UNION AERIAL SQUADRONS SPRUES

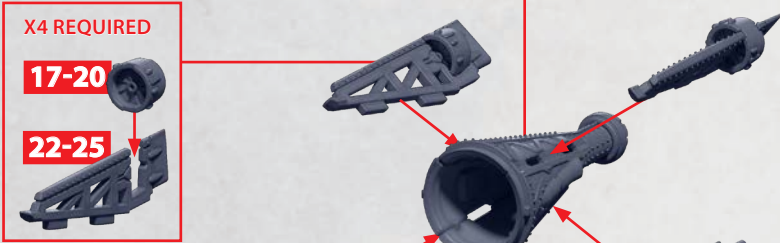
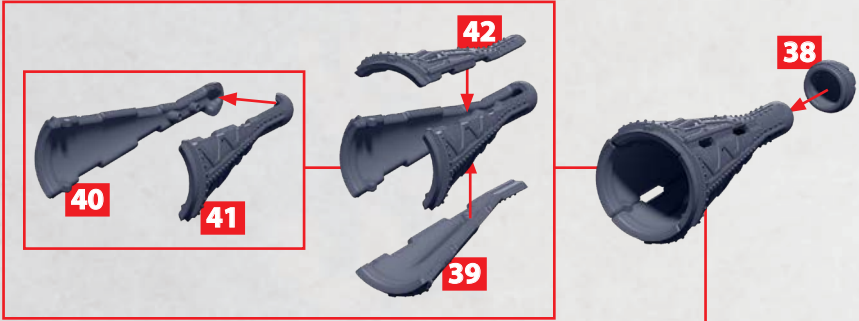

# HULL TO TAIL ASSEMBLY FOR STEWARD, CONSTELLATION, REPUBLIC, TICONDEROGA, RANGER

PARTS CAN BE FOUND ON THE **UNION AERIAL SQUADRONS** SPRUES

SEE PAGES 1 AND 2  
FOR ASSEMBLY

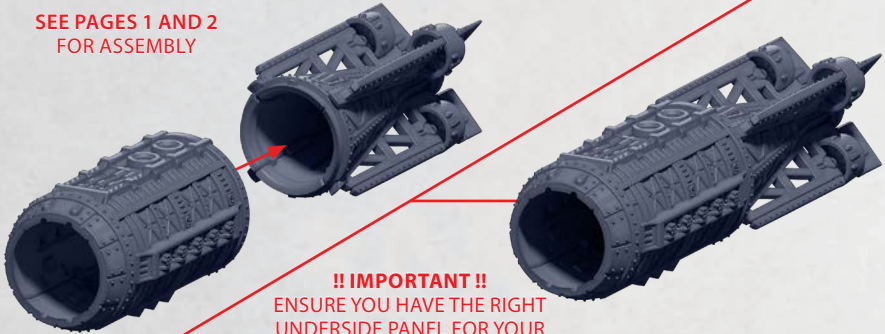

**!! IMPORTANT !!**

ENSURE YOU HAVE THE RIGHT  
UNDERSIDE PANEL FOR YOUR  
CHOSEN BUILD – PART 14, 37  
OR 43 (SEE PAGE 1 FOR DETAILS)

# EXCELSIOR, VENTURE, CUSTODIAN HULLS TO TAIL

PARTS CAN BE FOUND ON THE **UNION AERIAL SQUADRONS** SPRUES

**21**



**21**



**13**



SEE ABOVE  
FOR ASSEMBLY

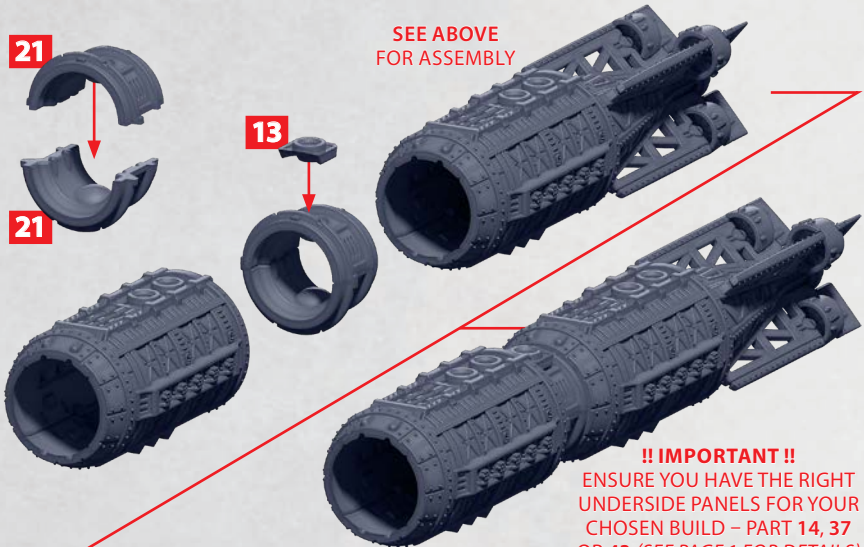

**!! IMPORTANT !!**

ENSURE YOU HAVE THE RIGHT  
UNDERSIDE PANELS FOR YOUR  
CHOSEN BUILD – PART 14, 37  
OR 43 (SEE PAGE 1 FOR DETAILS)

# EXCELSIOR HEAVY AIRCRUISER

PARTS CAN BE FOUND ON THE UNION AERIAL SQUADRONS SPRUES

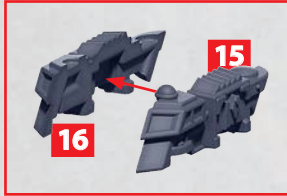

SEE PAGE 3 FOR ASSEMBLY

**!! IMPORTANT !!**

EXCELSIOR CARRIES 'BOMBS'  
PANEL (PART 14) TO BE FITTED  
FROM WITHIN BOTH HULL'S BASE  
(SEE PAGE 1 FOR ASSEMBLY)

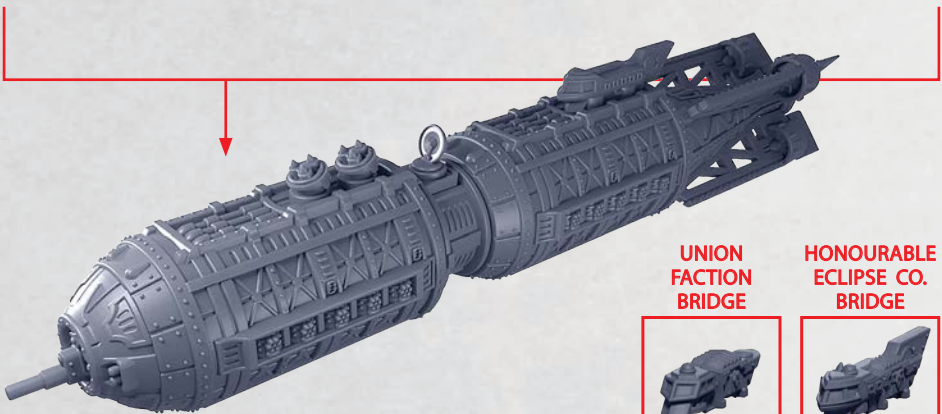

UNION  
FACTION  
BRIDGE



**15 & 16**

HONOURABLE  
ECLIPSE CO.  
BRIDGE



**44 & 45**

\* BRIDGES ARE INTERCHANGEABLE

# VENTURE ASSAULT AIRCRUISER

PARTS CAN BE FOUND ON THE UNION AERIAL SQUADRONS SPRUES

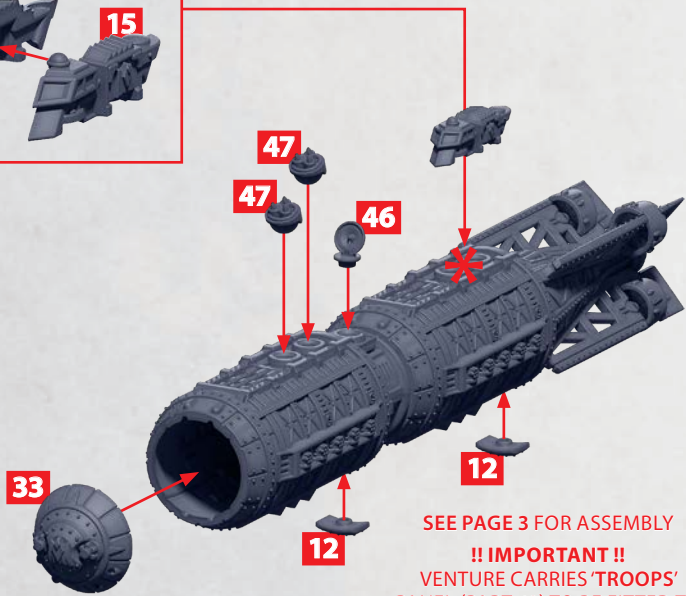
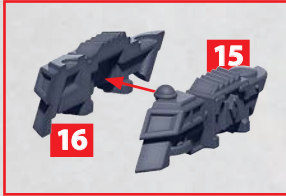

SEE PAGE 3 FOR ASSEMBLY

**!! IMPORTANT !!**

VENTURE CARRIES 'TROOPS'  
PANEL (PART 43) TO BE FITTED TO  
THE UNDERSIDE OF BOTH HULLS  
(SEE PAGE 1 FOR ASSEMBLY)

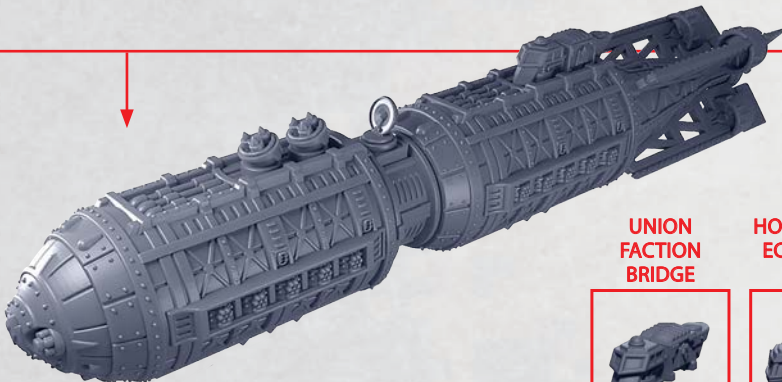

UNION  
FACTION  
BRIDGE



**15 & 16**

HONOURABLE  
ECLIPSE CO.  
BRIDGE



**44 & 45**

\* BRIDGES ARE INTERCHANGEABLE

# CUSTODIAN SENTRY AIRCRUISER

PARTS CAN BE FOUND ON THE UNION AERIAL SQUADRONS SPRUES



SEE PAGE 3  
FOR ASSEMBLY

**!! IMPORTANT !!**

CUSTODIAN CARRIES 'TROOPS' PANEL (PART 43) TO BE FITTED TO THE UNDERSIDE OF THE FRONT HULL AND CARRIES 'BOMBS' PANEL (PART 14) TO BE FITTED FROM WITHIN THE REAR HULL'S BASE (SEE PAGE 1 FOR ASSEMBLY)

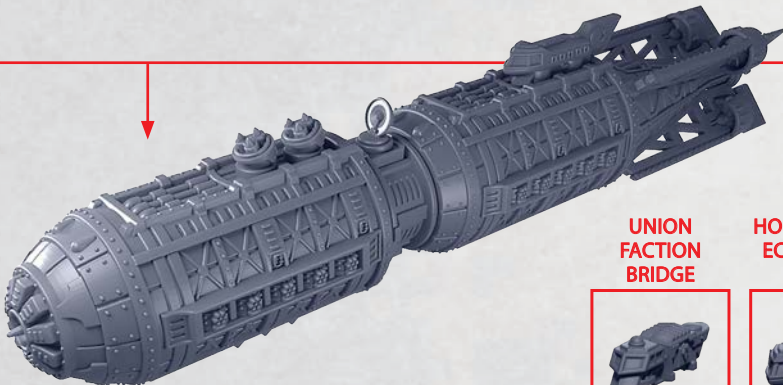

UNION  
FACTION  
BRIDGE



**15 & 16**

HONOURABLE  
ECLIPSE CO.  
BRIDGE



**44 & 45**

\* BRIDGES ARE INTERCHANGEABLE

# STEWARD SENTRY AIRSHIP

PARTS CAN BE FOUND ON THE UNION AERIAL SQUADRONS SPRUES



36



SEE PAGE 3  
FOR ASSEMBLY

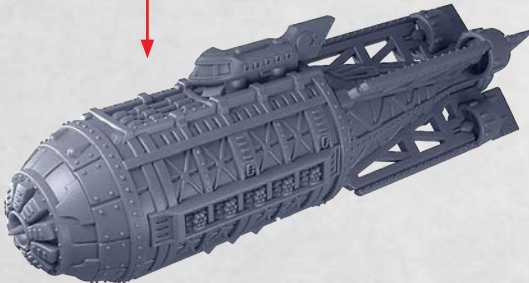

UNION  
FACTION  
BRIDGE



15 & 16

HONOURABLE  
ECLIPSE CO.  
BRIDGE



44 & 45

\* BRIDGES ARE INTERCHANGEABLE

# CONSTELLATION ATTACK AIRSHIP

PARTS CAN BE FOUND ON THE UNION AERIAL SQUADRONS SPRUES

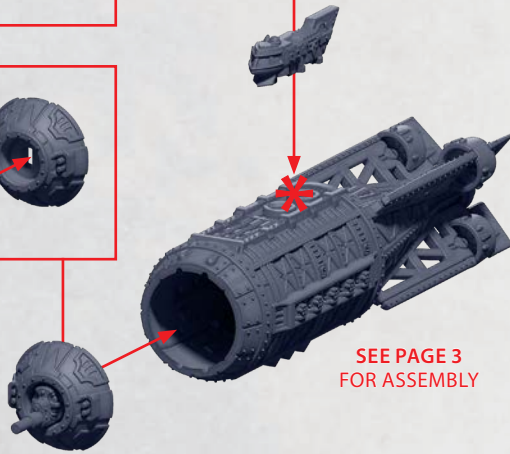

SEE PAGE 3  
FOR ASSEMBLY



UNION  
FACTION  
BRIDGE



15 & 16

HONOURABLE  
ECLIPSE CO.  
BRIDGE



44 & 45

\* BRIDGES ARE INTERCHANGEABLE



# REPUBLIC CLOUDRAKER AIRSHIP

PARTS CAN BE FOUND ON THE UNION AERIAL SQUADRONS SPRUES

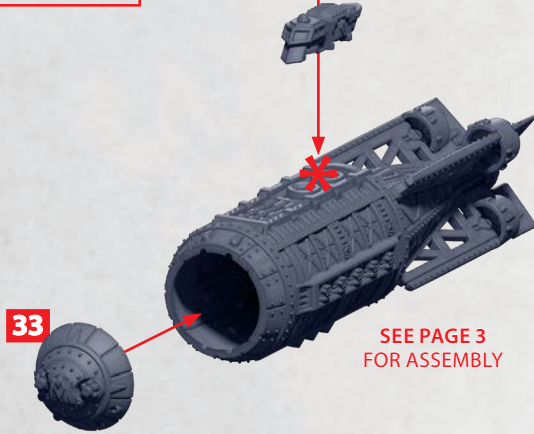
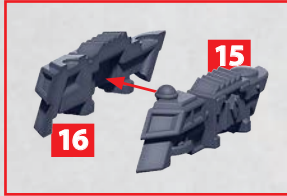

SEE PAGE 3  
FOR ASSEMBLY

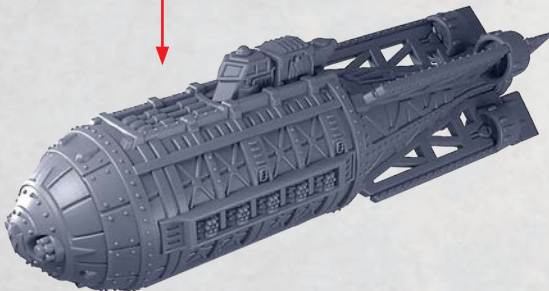

UNION  
FACTION  
BRIDGE



15 & 16

HONOURABLE  
ECLIPSE CO.  
BRIDGE



44 & 45

\* BRIDGES ARE INTERCHANGEABLE

# TICONDEROGA ASSAULT AIRSHIP

PARTS CAN BE FOUND ON THE **UNION AERIAL SQUADRONS** SPRUES

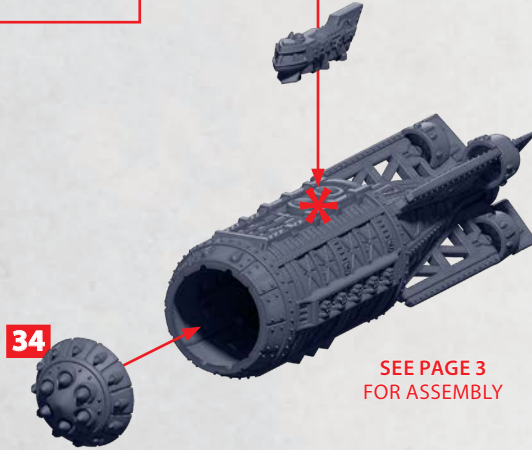

SEE PAGE 3  
FOR ASSEMBLY



UNION  
FACTION  
BRIDGE



15 & 16

HONOURABLE  
ECLIPSE CO.  
BRIDGE



44 & 45

\* BRIDGES ARE INTERCHANGEABLE

# RANGER RECON AIRSHIP

PARTS CAN BE FOUND ON THE **UNION AERIAL SQUADRONS** SPRUES

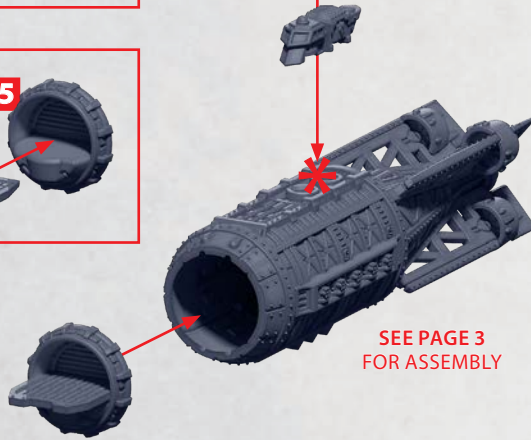
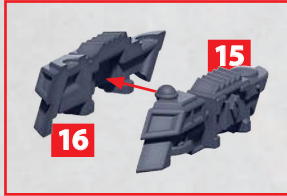

SEE PAGE 3  
FOR ASSEMBLY

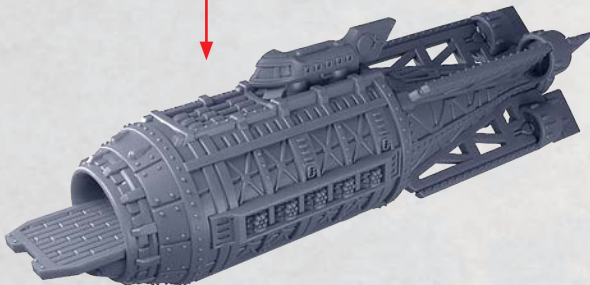

UNION  
FACTION  
BRIDGE



15 & 16

HONOURABLE  
ECLIPSE CO.  
BRIDGE



44 & 45

\* BRIDGES ARE INTERCHANGEABLE

# BOGOTA CARRYALL

PARTS CAN BE FOUND ON THE UNION AERIAL SQUADRONS SPRUES



CONTAINERS



1-4

FUEL



6 OR 7

TORPEDOS



10 OR 11

\* CARGO PARTS ARE INTERCHANGEABLE

# LYCEUM AERIAL DREADNOUGHT

PARTS CAN BE FOUND AS RESIN AND ON THE **CRIMSON LEAGUE SQUADRONS** SPRUES

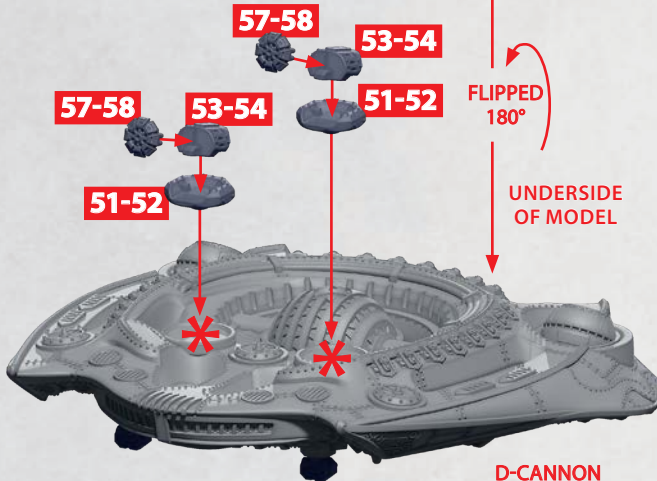
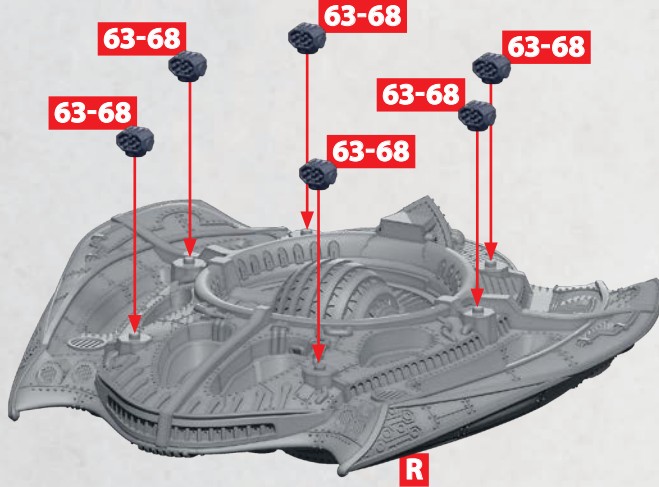

D-CANNON  
BATTERY



ROCKET  
BATTERY



\* ALL TURRETS ARE INTERCHANGEABLE

# LYCEUM AERIAL DREADNOUGHT

PARTS CAN BE FOUND AS RESIN AND ON THE CRIMSON LEAGUE SQUADRONS SPRUES

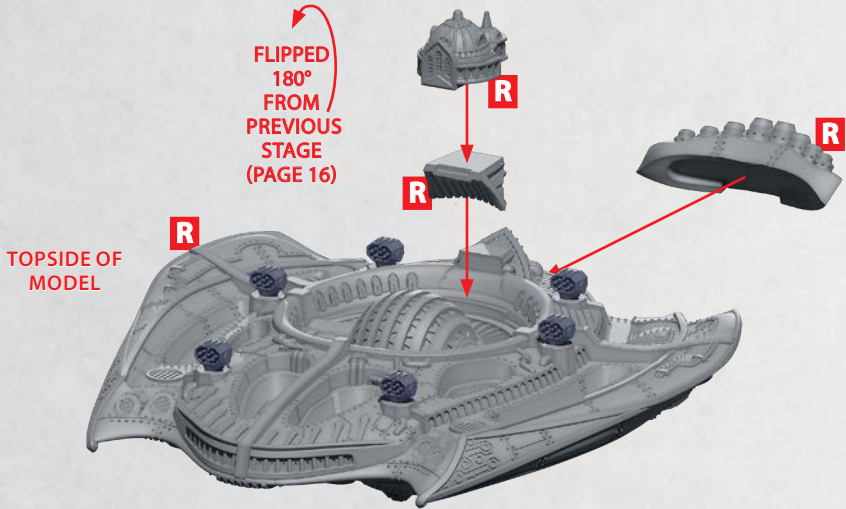

**R** = RESIN

# OLYMPIA CONVEYOR LOWER BOW, HULL & STERN

PARTS CAN BE FOUND ON THE TITAN CLASS HEAVY CONVEYOR SPRUES

**!! IMPORTANT !!**  
PICK REQUIRED BUILD (TITAN OR OLYMPIA CLASS) ON PAGES 22-27, BEFORE ANY ASSEMBLY

COMPLETED SINGLE BODY VESSEL HULL – CONSIDER THE POSITION OF FLIGHT STAND BEFORE ANY ASSEMBLY

**NOTE:** ON DOUBLE BODY VESSELS, ONE SECTION WILL NOT REQUIRE (RED) PART 2-4 AT THE FRONT OR BACK, DEPENDING WHERE YOU PLACE THE SECTION



PARTS 40 WILL ONLY REQUIRE PART 42-43 IN ONE SECTION WHEN ASSEMBLING THE DOUBLE BODY VESSEL (NOT REQUIRED ON SINGLE HULL VERSION) – CONSIDER THE POSITION OF FLIGHT STAND BEFORE ANY ASSEMBLY

\* HOLE FOR FLIGHT STAND  
PART 42-43

THE EXTRA SECTION FOR THE DOUBLE BODY VESSEL CAN BE ROTATED TO FIT EITHER THE FRONT OR BACK OF THE SINGLE SECTION (FAR LEFT) – CONSIDER THE POSITION OF FLIGHT STAND BEFORE ANY ASSEMBLY

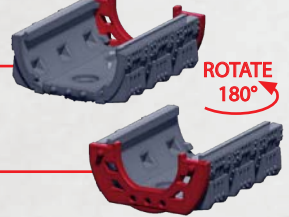

# TITAN & OLYMPIA CONVEYOR UPPER BOW & STERN

PARTS CAN BE FOUND ON THE TITAN CLASS HEAVY CONVEYOR SPRUES

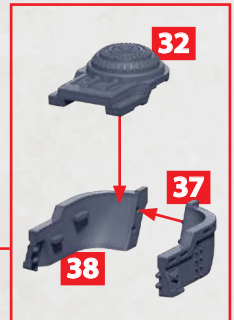
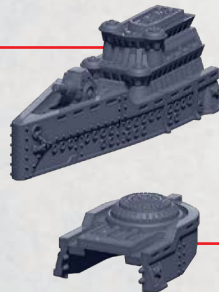
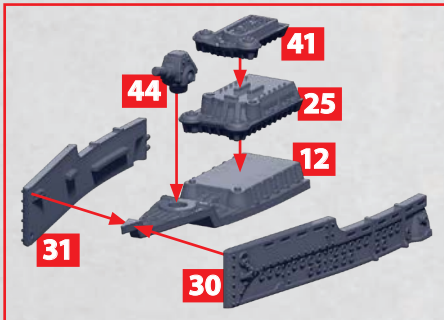

# TITAN AND OLYMPIA CONVEYOR CARGO

PARTS CAN BE FOUND ON THE **TITAN CLASS HEAVY CONVEYOR SPRUES**

## SINGLE BODY VESSEL (OR FRONT OF DOUBLE BODY VESSEL)

**NOTE:** THE SINGLE BODY VESSEL ONLY  
REQUIRES PART 7 (INDICATED RED) –  
IF PART OF THE DOUBLE BODY VESSEL  
THEN PART 7 IS OMITTED HERE



## DOUBLE BODY VESSEL ONLY (REAR SECTION)

**NOTE:** WHEN CONSTRUCTING A  
DOUBLE BODY VESSEL THEN PART 7  
(INDICATED RED) MOVES TO THE REAR  
OF THIS SECTION – *SEE NOTE LEFT*

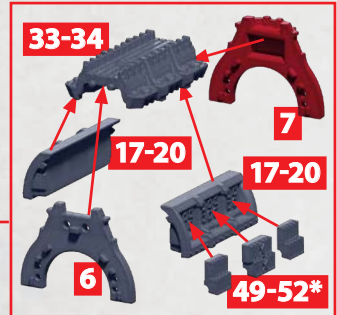
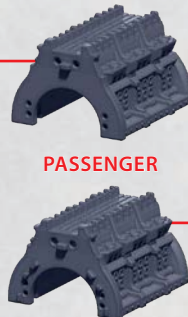

\*REPEAT ATTACHMENT OF PARTS 49-52 ON OPPOSITE SIDE OF MODEL



# TITAN AND OLYMPIA CONVEYOR UPPER ASSEMBLY

PARTS CAN BE FOUND ON THE **TITAN CLASS HEAVY CONVEYOR SPRUES**

CAN BE BUILT AS EITHER **SINGLE**  
OR **DOUBLE** BODY MODELS

SEE PAGE 18 FOR CARGO BUILD  
(OIL, PASSENGER OR FREIGHT) OPTIONS

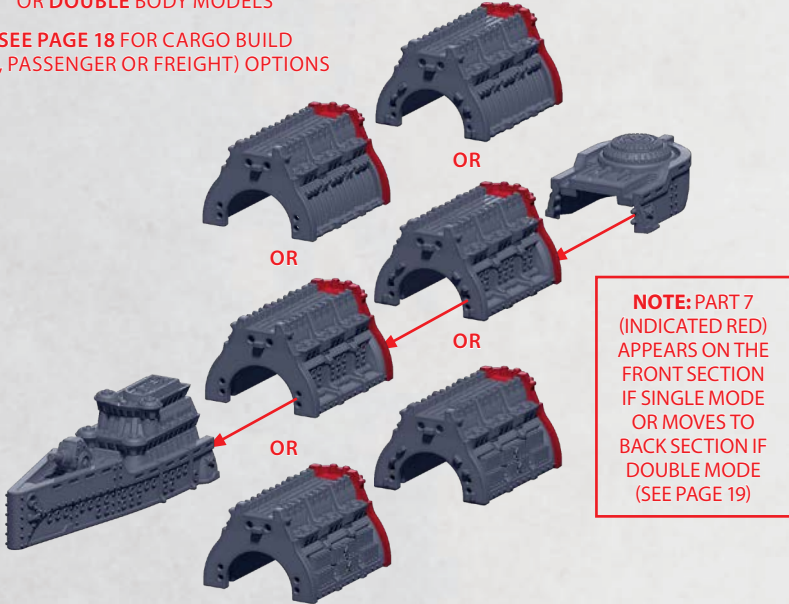

BOTH EXAMPLES BELOW SHOWN WITH PASSENGER CARGO SECTIONS

**SINGLE BODY  
VESSEL**

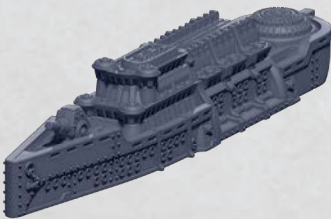

**DOUBLE BODY  
VESSEL**

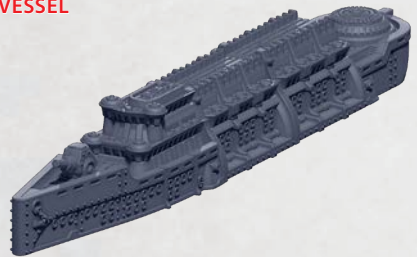

# OLYMPIA CONVEYOR LOWER ASSEMBLY

PARTS CAN BE FOUND ON THE **TITAN CLASS HEAVY CONVEYOR** SPRUES

RECOMMENDED  
POSITION OF FLIGHT  
STAND FOR **SINGLE  
HULL VESSEL** IS  
THE FRONT OF THE  
SECTION TOWARD  
THE BOW

RECOMMENDED  
POSITION OF FLIGHT  
STAND FOR **DOUBLE  
HULL VESSEL** IS THE  
REAR OF THE FRONT  
HULL SECTION  
TOWARD THE CENTRE

CAN BE BUILT AS EITHER **SINGLE**  
OR **DOUBLE** BODY MODELS

SEE PAGE 15 FOR ASSEMBLY  
OF EACH SECTION

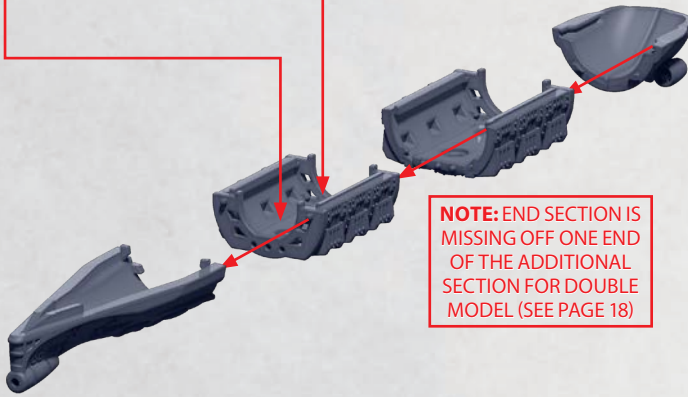

**NOTE:** END SECTION IS  
MISSING OFF ONE END  
OF THE ADDITIONAL  
SECTION FOR DOUBLE  
MODEL (SEE PAGE 18)

**SINGLE BODY  
VESSEL**

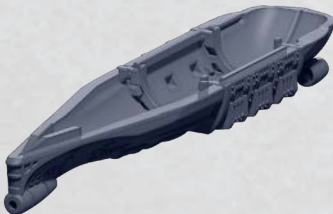

**DOUBLE BODY  
VESSEL**



# TITAN CONVEYOR PASSENGER

PARTS CAN BE FOUND ON THE **TITAN CLASS HEAVY CONVEYOR** SPRUES

FUNNELS

36

35

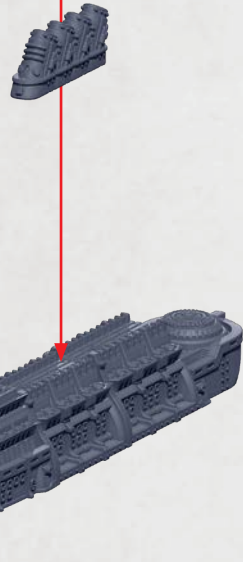
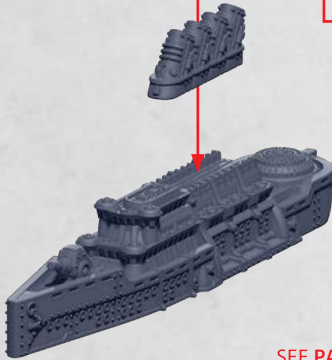

SEE PAGES 18-20  
FOR ASSEMBLY

SINGLE BODY  
VESSEL

DOUBLE BODY  
VESSEL

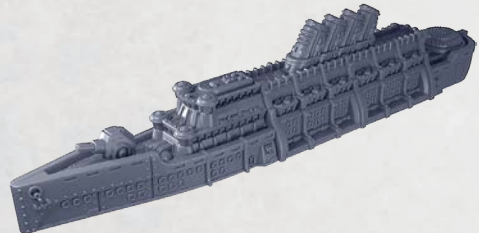
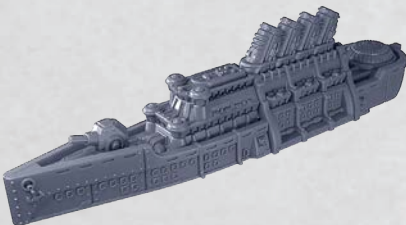

# OLYMPIA CONVEYOR PASSENGER

PARTS CAN BE FOUND ON THE TITAN CLASS HEAVY CONVEYOR SPRUES



SEE PAGE 19  
FOR FUNNEL  
ASSEMBLY AND  
ATTACHEMENT

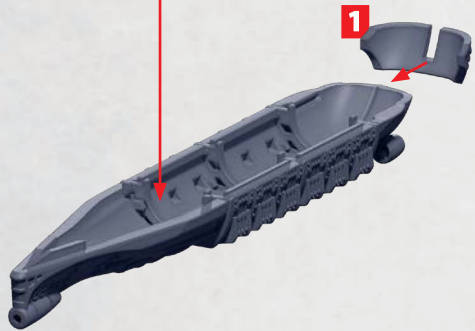
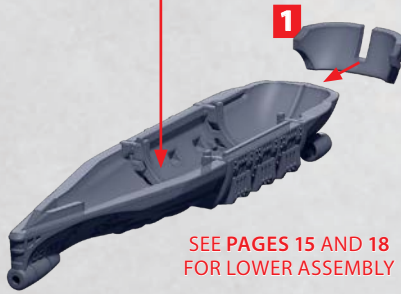
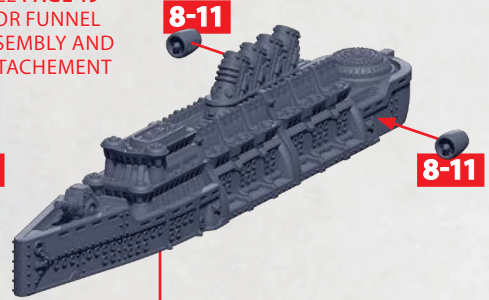

SINGLE BODY  
VESSEL

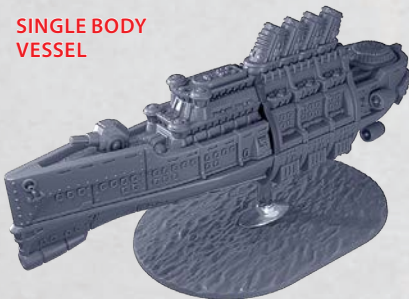

DOUBLE BODY  
VESSEL



# TITAN CONVEYOR OIL

PARTS CAN BE FOUND ON THE **TITAN CLASS HEAVY CONVEYOR** SPRUES

CRANE

**60-61** OR **70**

**62-63** OR **66**

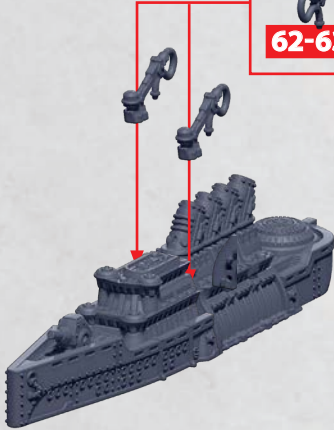

SEE PAGE 19  
FOR FUNNEL  
ASSEMBLY AND  
ATTACHMENT

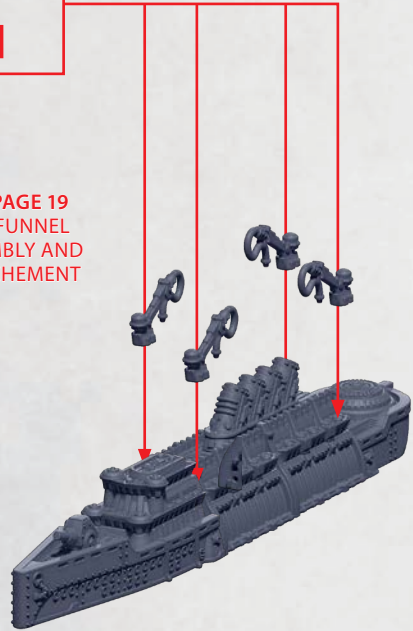

SEE PAGES 18-20  
FOR ASSEMBLY

SINGLE BODY  
VESSEL



DOUBLE BODY  
VESSEL

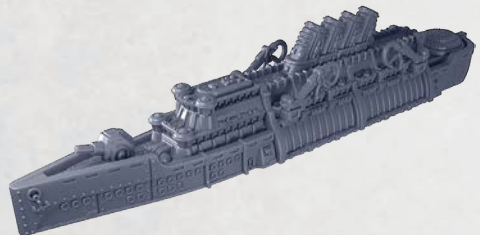

# OLYMPIA CONVEYOR OIL

PARTS CAN BE FOUND ON THE TITAN CLASS HEAVY CONVEYOR SPRUES

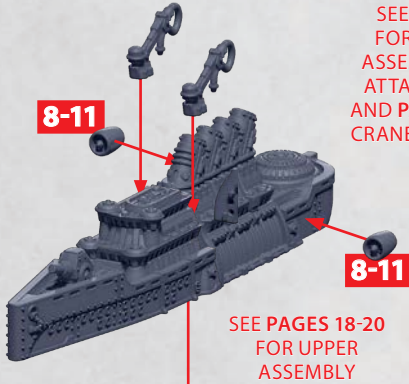

SEE PAGE 19  
FOR FUNNEL  
ASSEMBLY AND  
ATTACHEMENT  
AND PAGE 21 FOR  
CRANE ASSEMBLY

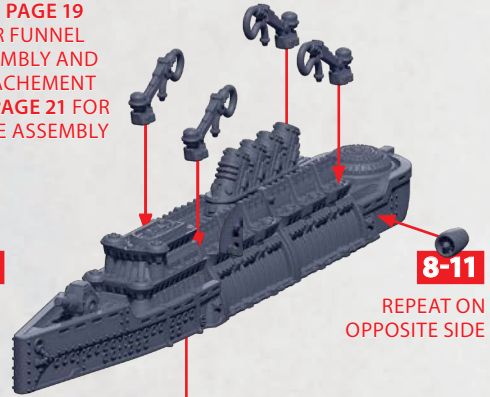

REPEAT ON  
OPPOSITE SIDE

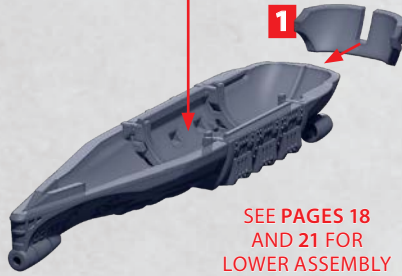

SEE PAGES 18  
AND 21 FOR  
LOWER ASSEMBLY



SINGLE BODY  
VESSEL



DOUBLE BODY  
VESSEL



# TITAN CONVEYOR FREIGHT

PARTS CAN BE FOUND ON THE TITAN CLASS HEAVY CONVEYOR SPRUES

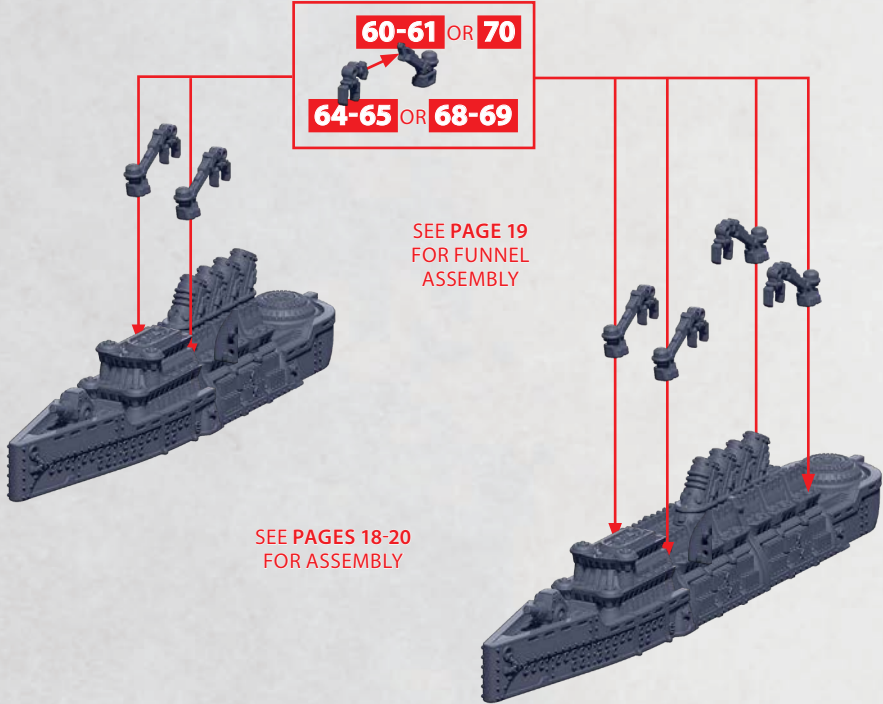

SINGLE BODY  
VESSEL

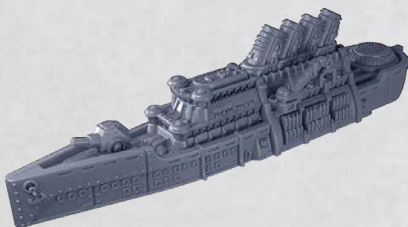

DOUBLE BODY  
VESSEL

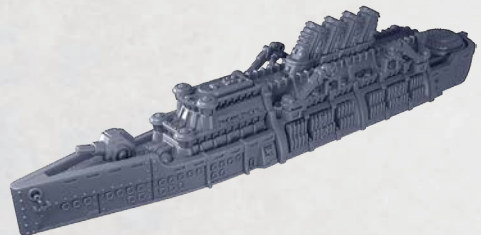

# OLYMPIA CONVEYOR FREIGHT

PARTS CAN BE FOUND ON THE TITAN CLASS HEAVY CONVEYOR SPRUES

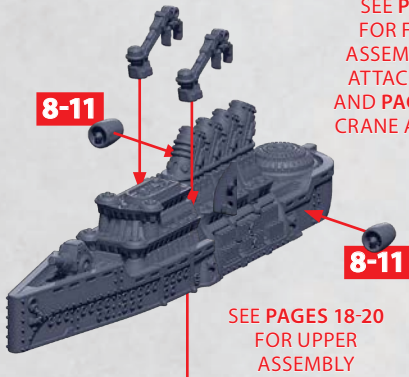

SEE PAGE 19  
FOR FUNNEL  
ASSEMBLY AND  
ATTACHEMENT  
AND PAGE 23 FOR  
CRANE ASSEMBLY

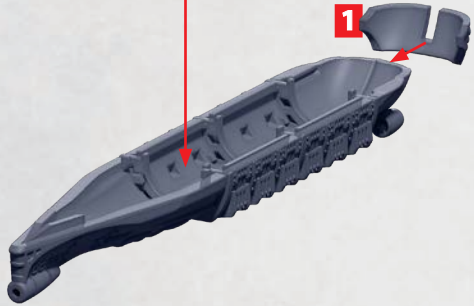
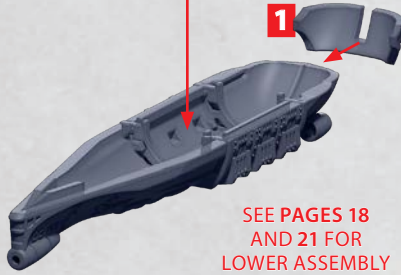
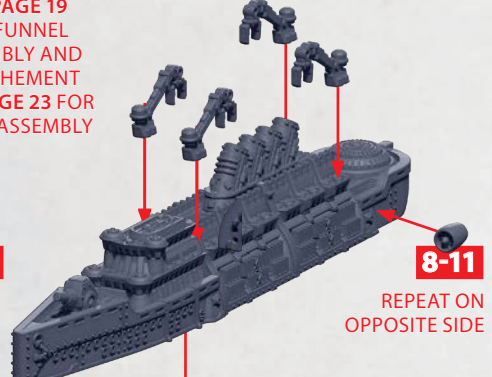

SINGLE BODY  
VESSEL



DOUBLE BODY  
VESSEL





# NASR, AWSBIRI AND MUHARIB HULL

PARTS CAN BE FOUND ON THE **CRIMSON LEAGUE SQUADRONS** SPRUES

BRIDGE  
& DECK

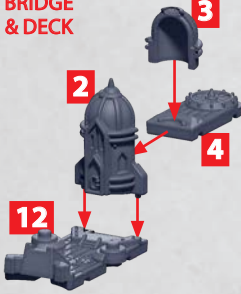

**!! IMPORTANT !!**  
BE SURE TO ATTACH THE  
BRIDGE & DECK ASSEMBLY  
AND PART 9 TO EITHER PARTS  
10 OR 11 BEFORE ATTACHING  
THE OPPOSITE SIDE

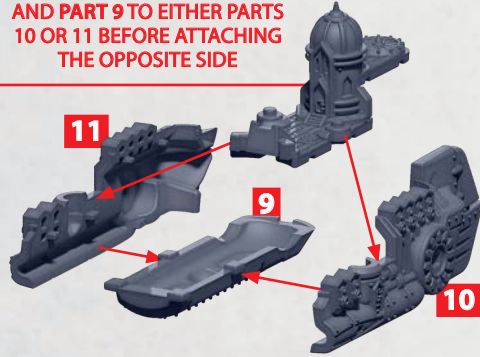

14



13



8

7

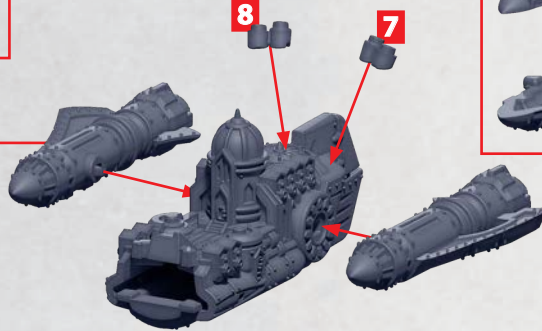

23



# NASR SKYSHIP

PARTS CAN BE FOUND ON THE **CRIMSON LEAGUE SQUADRONS** SPRUES

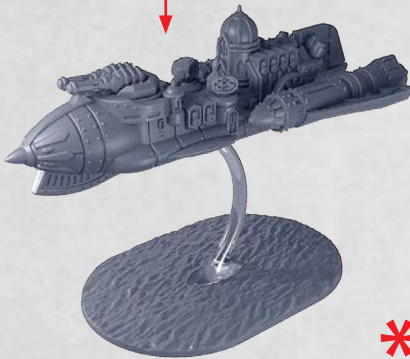
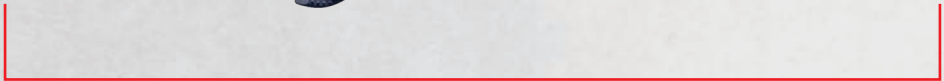
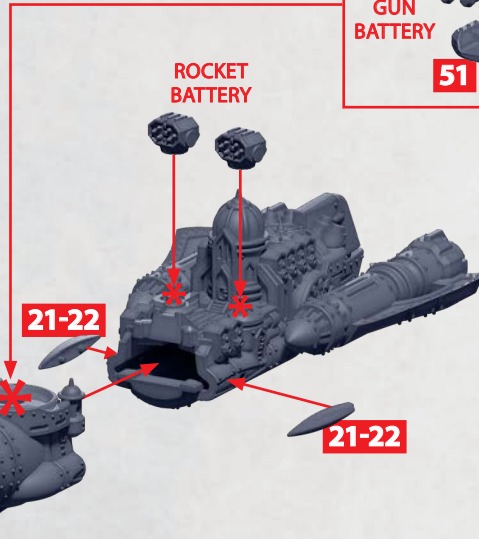
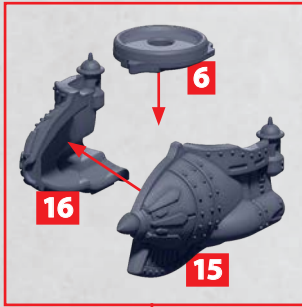

\*ALL TURRETS ARE INTERCHANGEABLE  
\*\*REQUIRES PART 53 OR 54

# AWSBIRI SKYLANCER

PARTS CAN BE FOUND ON THE **CRIMSON LEAGUE SQUADRONS** SPRUES

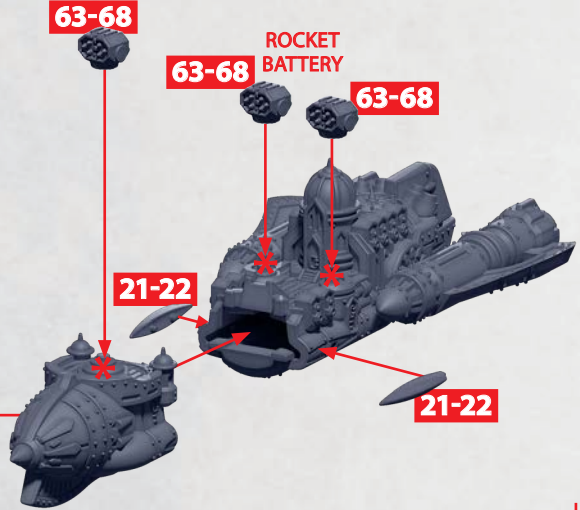
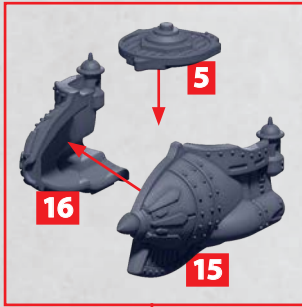

\*ALL TURRETS ARE INTERCHANGEABLE



# MUHARIB SKYRUNNER

PARTS CAN BE FOUND ON THE **CRIMSON LEAGUE SQUADRONS** SPRUES

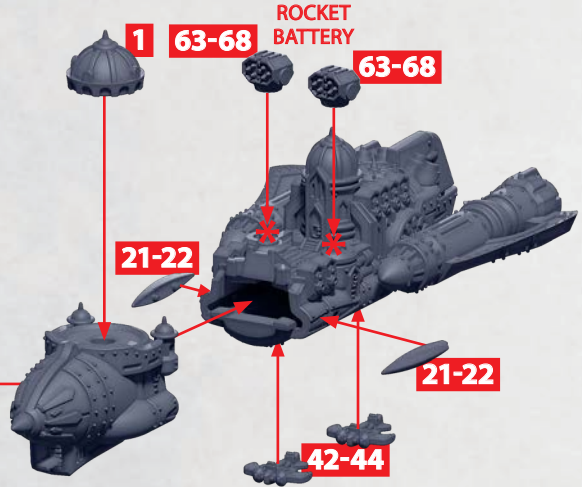
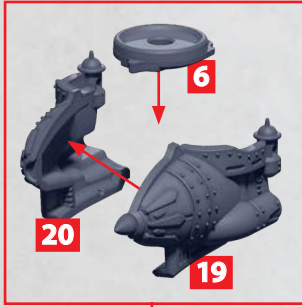

\*ALL TURRETS ARE INTERCHANGEABLE

# HIRKA SKYCUTTER

PARTS CAN BE FOUND ON THE **CRIMSON LEAGUE SQUADRONS** SPRUES

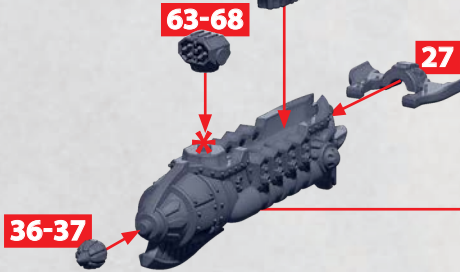
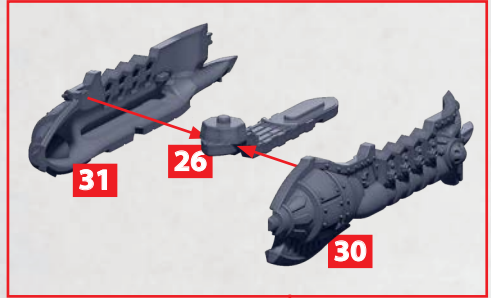

\*ALL TURRETS ARE  
INTERCHANGEABLE

GUN  
BATTERY



45-50

AETHERIC  
LANCE



69-74

# ALSAQR SKYBARQUE

PARTS CAN BE FOUND ON THE **CRIMSON LEAGUE SQUADRONS** SPRUES

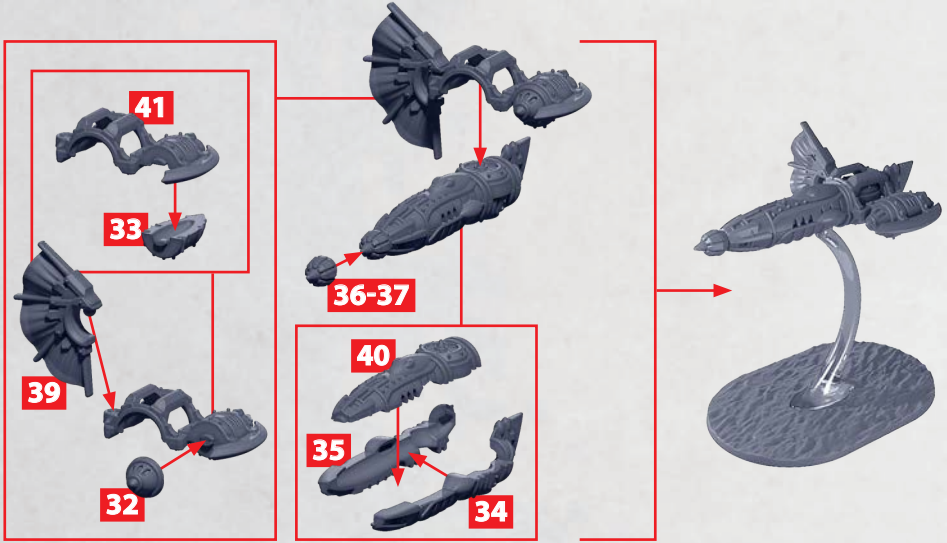

## ALSO INCLUDED

### GROUND ASSAULT DETACHMENT TOKEN

FOUND ON THE **TITAN CLASS  
HEAVY CONVEYOR** SPRUES



### CARGO TOKEN

FOUND ON THE **TITAN CLASS  
HEAVY CONVEYOR** SPRUES

