

LANCELOT CLASS HEAVY CRUISER

PARTS CAN BE FOUND ON THE CROWN FRONTLINE SPRUES

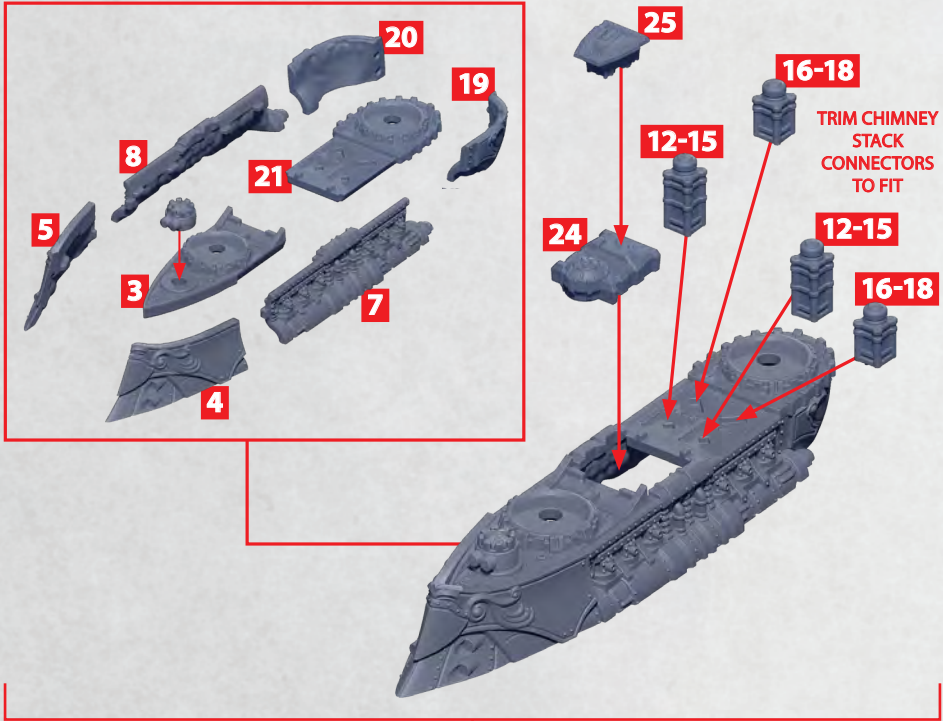

TRIM CHIMNEY
STACK
CONNECTORS
TO FIT

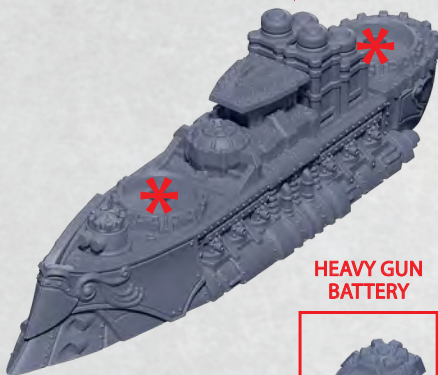

HEAVY GUN
BATTERY

HEAVY
TORPEDO
TURRET

HEAVY
ROCKET
BATTERY



34-37



38-41



42-44

* ALL TURRETS ARE INTERCHANGEABLE

SABRE CLASS COMMAND CRUISER

LABELLED PARTS CAN BE FOUND ON THE CROWN FRONTLINE SPRUES

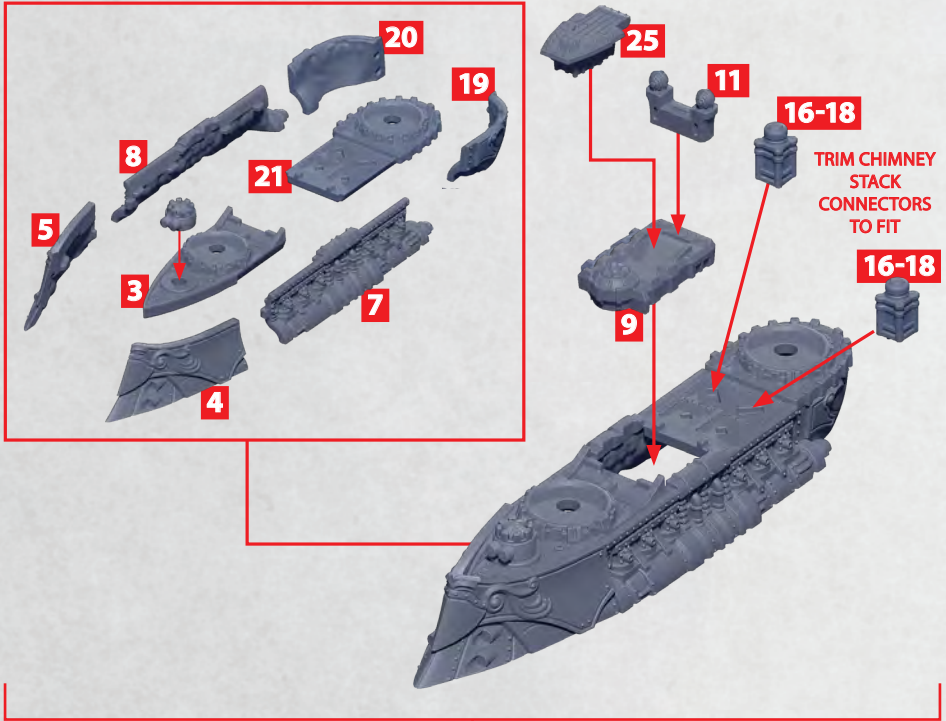

TRIM CHIMNEY
STACK
CONNECTORS
TO FIT

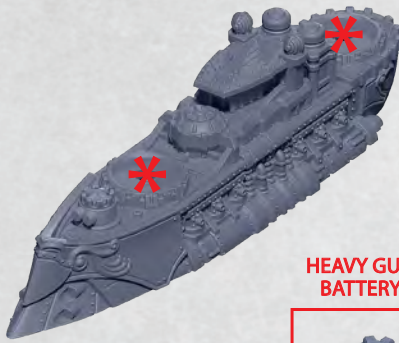

HEAVY GUN
BATTERY



34-37

HEAVY
TORPEDO
TURRET



38-41

HEAVY
ROCKET
BATTERY



42-44

* ALL TURRETS ARE INTERCHANGEABLE

ALBION CLASS CRUISER

PARTS CAN BE FOUND ON THE CROWN FRONTLINE SPRUES

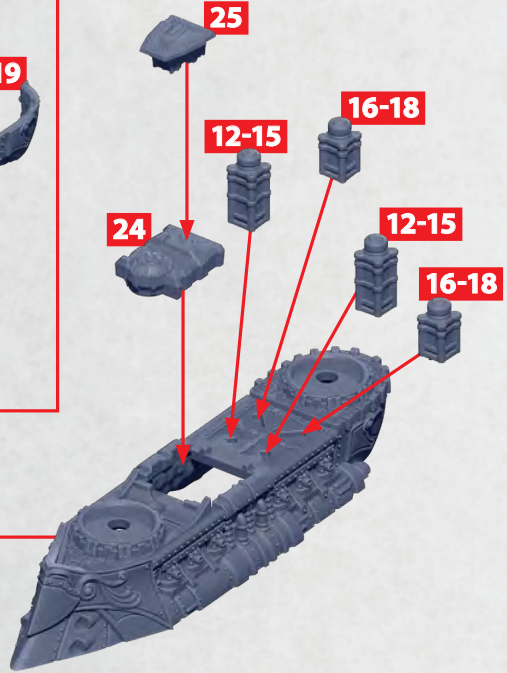

HEAVY
GUN
BATTERY



34-37

HEAVY
TORPEDO
TURRET



38-41

HEAVY
ROCKET
BATTERY



42-44

* ALL TURRETS ARE INTERCHANGEABLE

BEDIVERE CLASS CRUISER

PARTS CAN BE FOUND ON THE CROWN FRONTLINE SPRUES

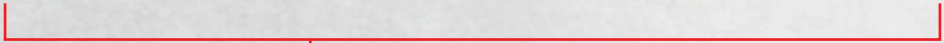
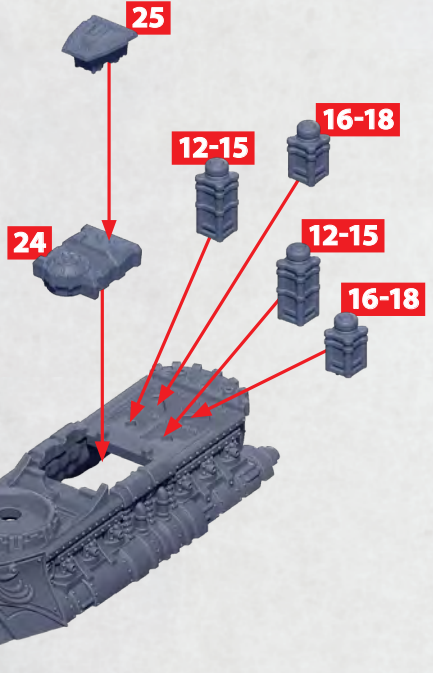
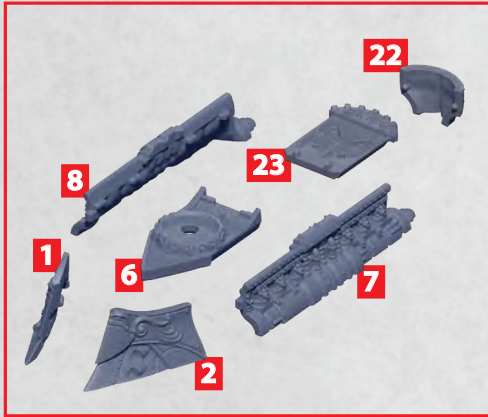

* ALL TURRETS ARE INTERCHANGEABLE

HEAVY GUN
BATTERY



HEAVY
TORPEDO
TURRET



HEAVY
ROCKET
BATTERY



PICTON CLASS CRUISER

LABELLED PARTS CAN BE FOUND ON THE CROWN FRONTLINE SPRUES

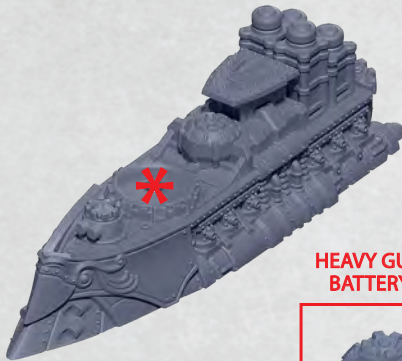
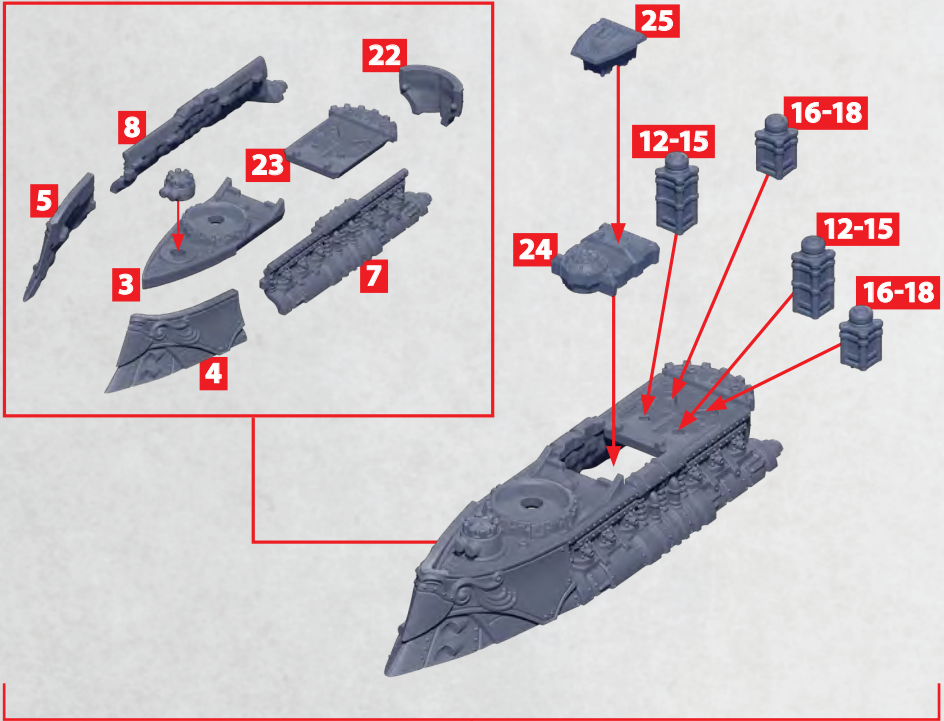

HEAVY GUN BATTERY



34-37

HEAVY TORPEDO TURRET



38-41

HEAVY ROCKET BATTERY



42-44

* ALL TURRETS ARE INTERCHANGEABLE

CALIBURN CLASS FRIGATE

LABELLED PARTS CAN BE FOUND ON THE CROWN FRONTLINE SQUADRONS SPRUES

