

BRITANNIA BATTLESHIP

PARTS CAN BE FOUND ON THE **CROWN FRONTLINE** SPRUES



12-15

ELEMENTS IN BOXES, WHEN FIXED INTO
POSITION INDIVIDUALLY, COMBINE TO
FORM THE GROUPED ELEMENT BELOW



16-18

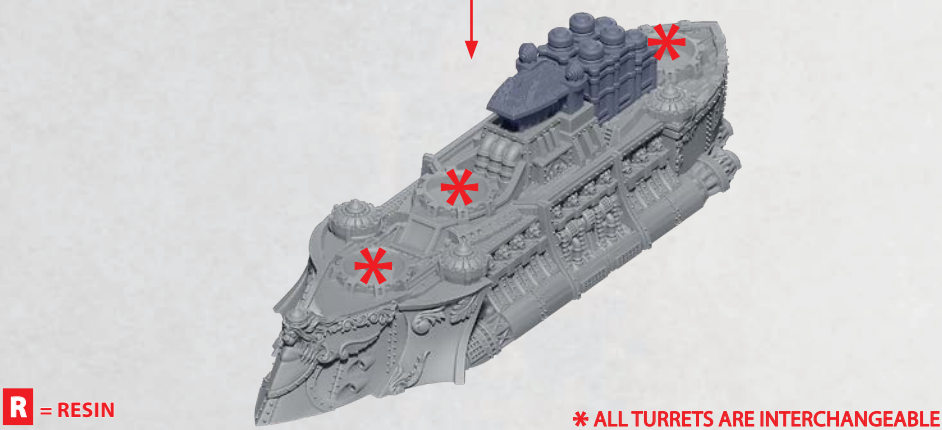
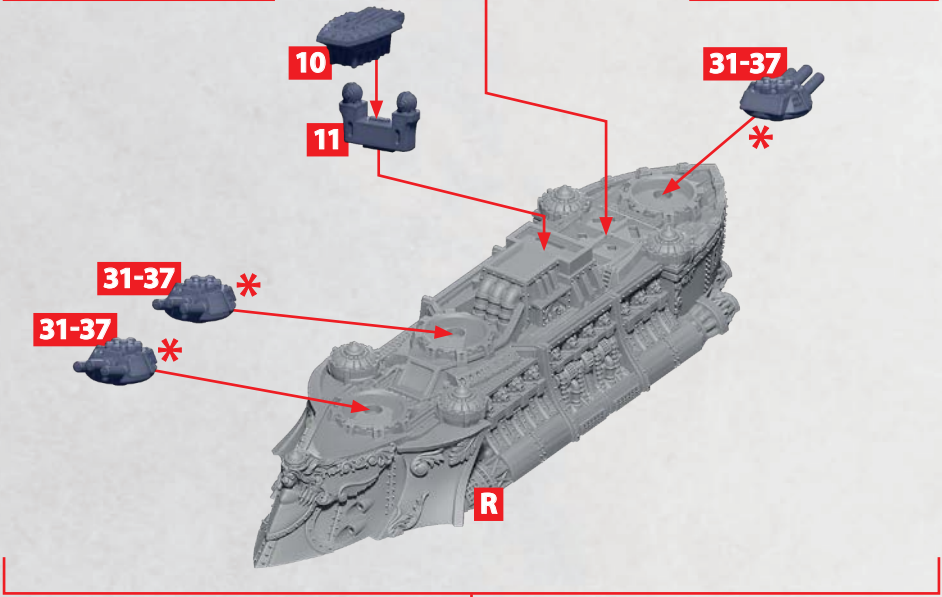

R = RESIN

*** ALL TURRETS ARE INTERCHANGEABLE**

LANCELOT CLASS HEAVY CRUISER

PARTS CAN BE FOUND ON THE CROWN FRONTLINE SPRUES

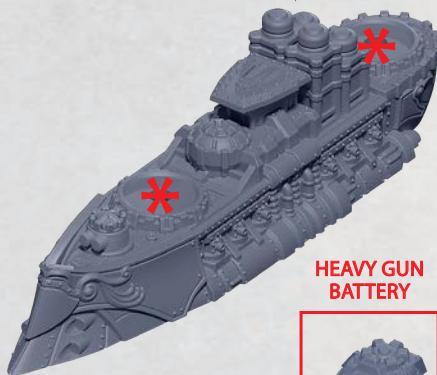
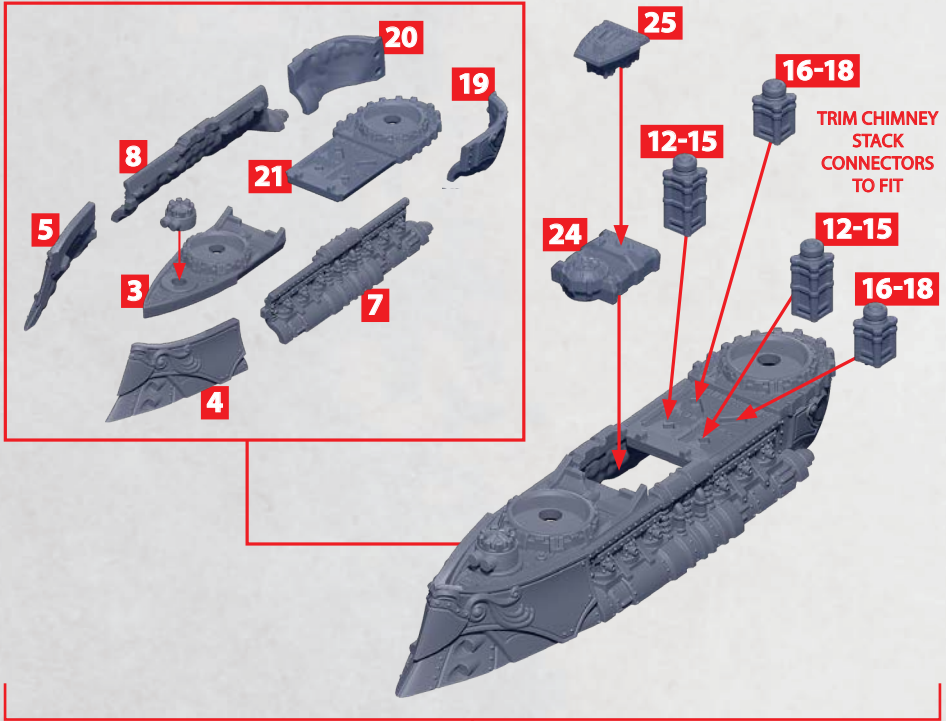

HEAVY GUN
BATTERY



34-37

HEAVY
TORPEDO
TURRET



38-41

HEAVY
ROCKET
BATTERY



42-44

* ALL TURRETS ARE INTERCHANGEABLE

SABRE CLASS COMMAND CRUISER

LABELLED PARTS CAN BE FOUND ON THE CROWN FRONTLINE SPRUES

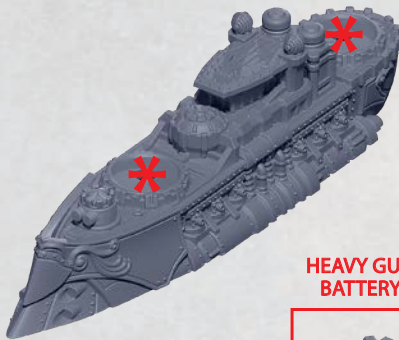
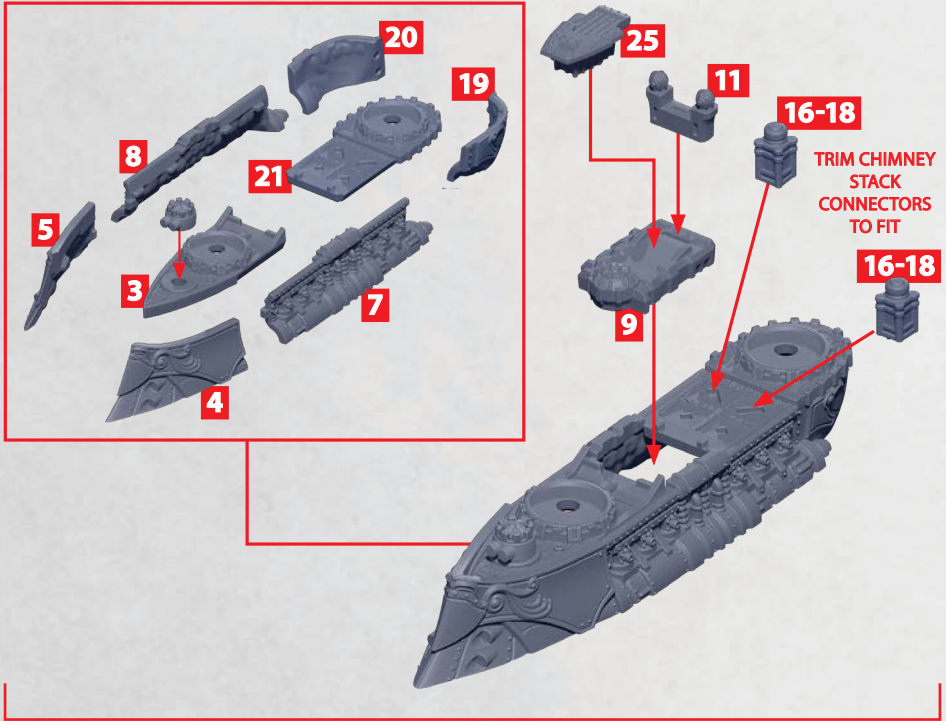

HEAVY GUN
BATTERY



34-37

HEAVY
TORPEDO
TURRET



38-41

HEAVY
ROCKET
BATTERY



42-44

* ALL TURRETS ARE INTERCHANGEABLE

ALBION CLASS CRUISER

PARTS CAN BE FOUND ON THE CROWN FRONTLINE SPRUES

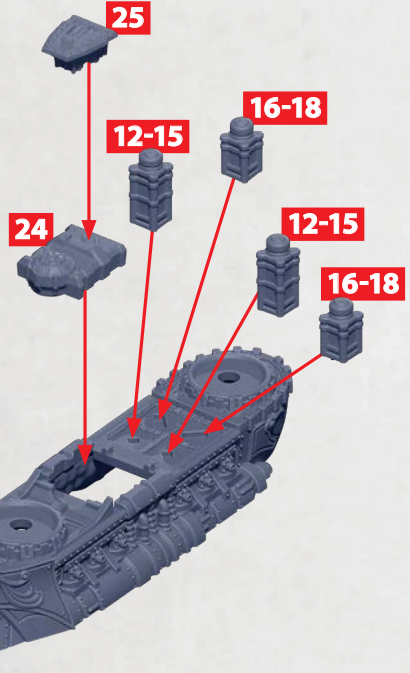

HEAVY GUN
BATTERY



34-37

HEAVY
TORPEDO
TURRET



38-41

HEAVY
ROCKET
BATTERY



42-44

* ALL TURRETS ARE INTERCHANGEABLE

BEDIVERE CLASS CRUISER

PARTS CAN BE FOUND ON THE CROWN FRONTLINE SPRUES

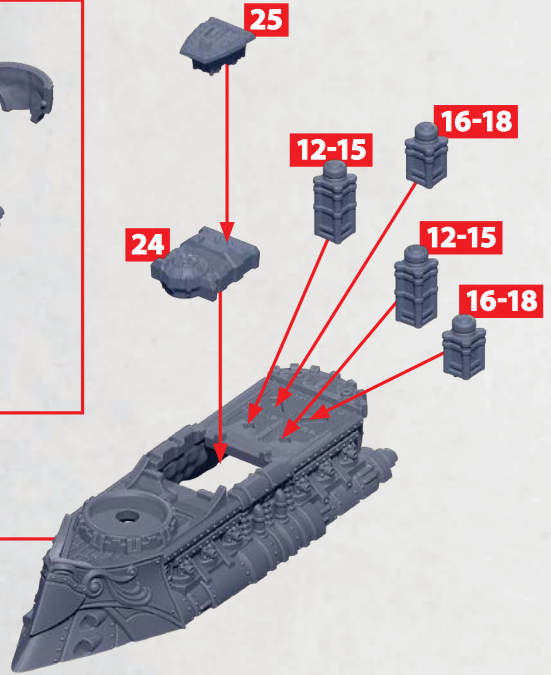
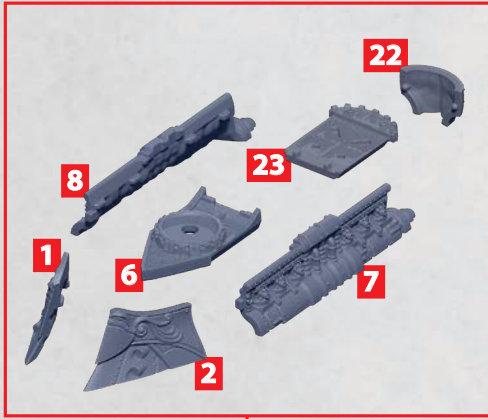

* ALL TURRETS ARE INTERCHANGEABLE

HEAVY GUN
BATTERY



34-37

HEAVY
TORPEDO
TURRET



38-41

HEAVY
ROCKET
BATTERY



42-44

PICTON CLASS CRUISER

LABELLED PARTS CAN BE FOUND ON THE CROWN FRONTLINE SPRUES

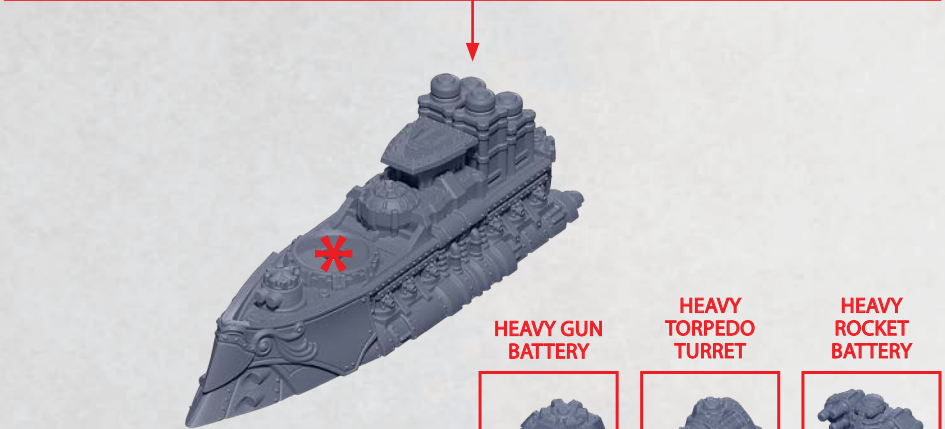
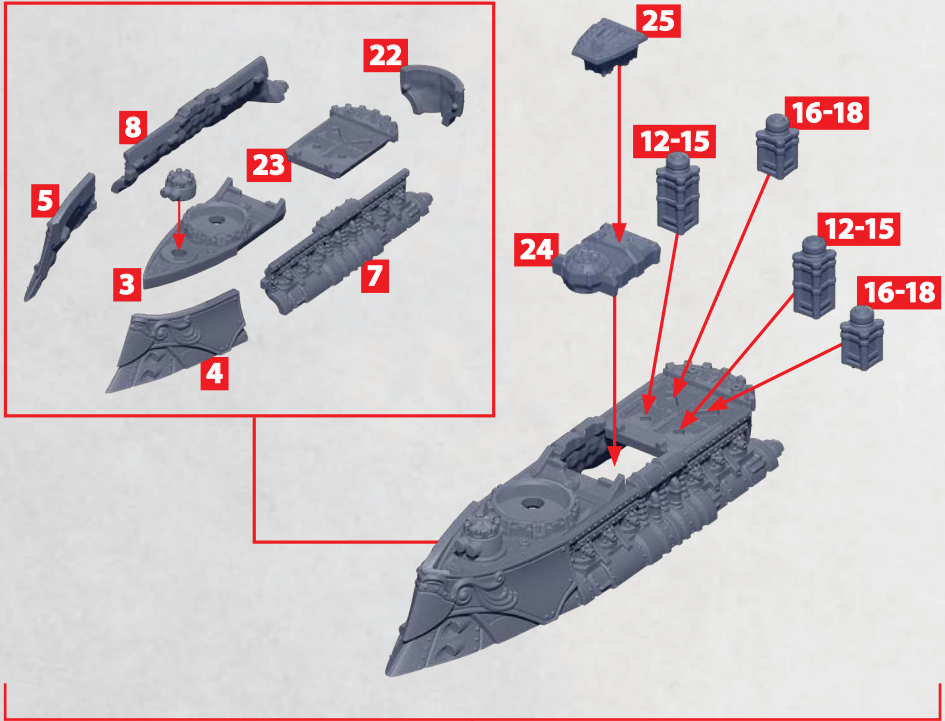

* ALL TURRETS ARE INTERCHANGEABLE

HEAVY GUN
BATTERY



HEAVY TORPEDO
TURRET



HEAVY ROCKET
BATTERY



CALIBURN CLASS FRIGATE

LABELLED PARTS CAN BE FOUND ON THE CROWN FRONTLINE SQUADRONS SPRUES

