

GETTYSBURG, PROVIDENCE, SARATOGA AND SUMTER CLASS CRUISER HULL

PARTS CAN BE FOUND ON THE ORE WAR VETERANS SQUADRONS SPRUES

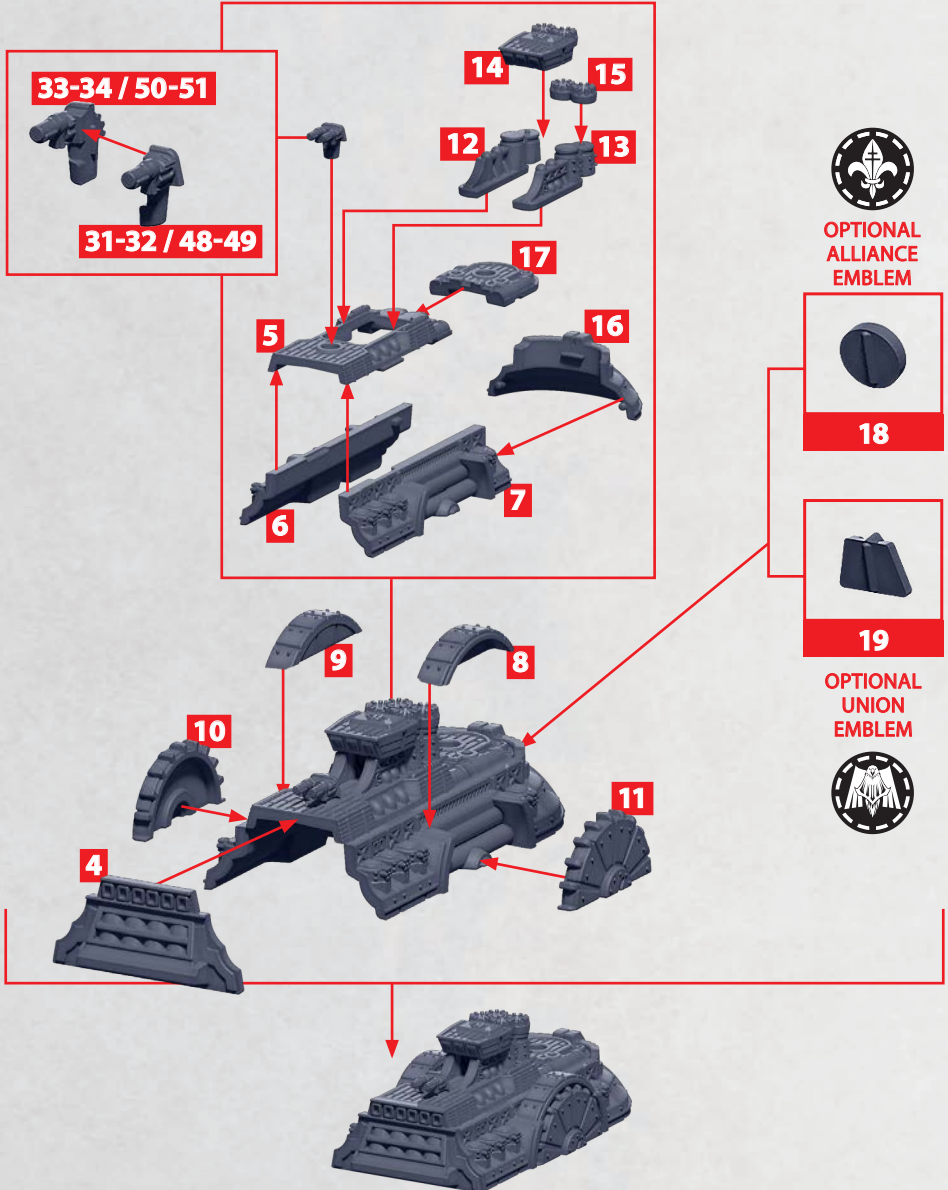

GETTYSBURG CLASS CRUISER

PARTS CAN BE FOUND ON THE ORE WAR VETERANS SQUADRONS SPRUES

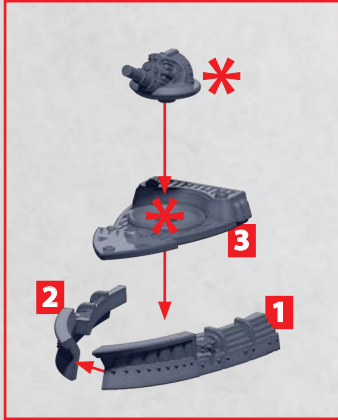

SEE PAGE 3
FOR GUN
ASSEMBLY



SEE PAGE 3
FOR AFT
ASSEMBLY



ALLIANCE
TURRETS



38 / 56-57



UNION
TURRETS



35 / 52-53

* ALL TURRETS ARE INTERCHANGEABLE

PROVIDENCE CLASS CRUISER

PARTS CAN BE FOUND ON THE ORE WAR VETERANS SQUADRONS SPRUES

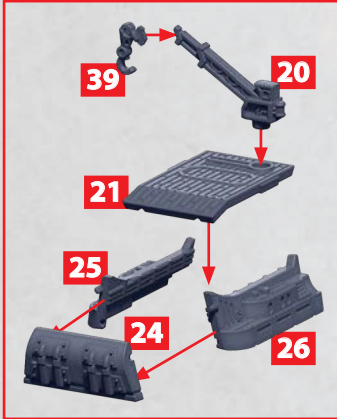

SEE PAGE 3
FOR GUN
ASSEMBLY

SEE PAGE 3
FOR AFT
ASSEMBLY

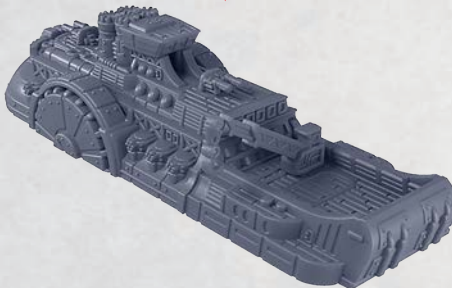
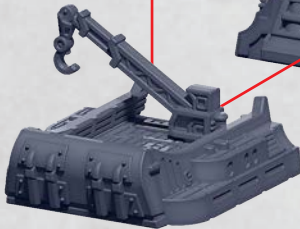

SARATOGA CLASS CRUISER

PARTS CAN BE FOUND ON THE ORE WAR VETERANS SQUADRONS SPRUES

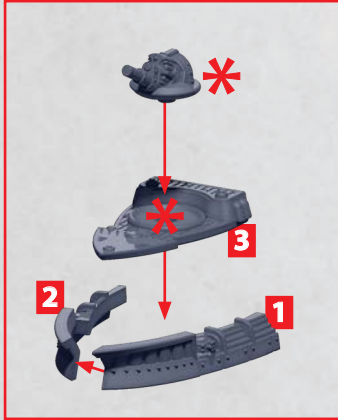

SEE PAGE 3 FOR AFT ASSEMBLY



ALLIANCE TURRETS



38 / 56-57



UNION TURRETS



35 / 52-53

* ALL TURRETS ARE INTERCHANGEABLE

SUMTER CLASS CRUISER

PARTS CAN BE FOUND ON THE ORE WAR VETERANS SQUADRONS SPRUES

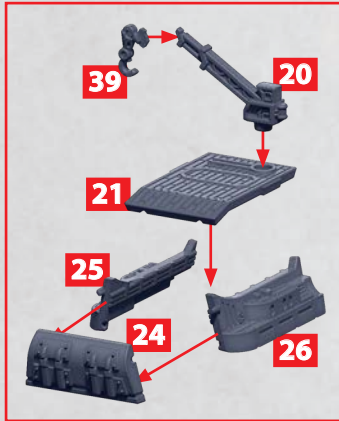

SEE PAGE 3
FOR AFT
ASSEMBLY

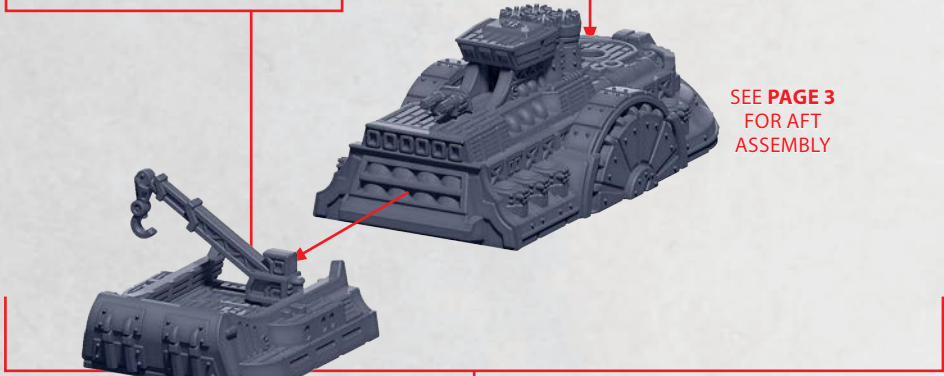

SPRINGFIELD CLASS CORVETTE

PARTS CAN BE FOUND ON THE ORE WAR VETERANS SQUADRONS SPRUES

33-34 / 50-51



31-32 / 48-49

46-47

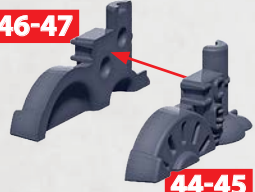

44-45

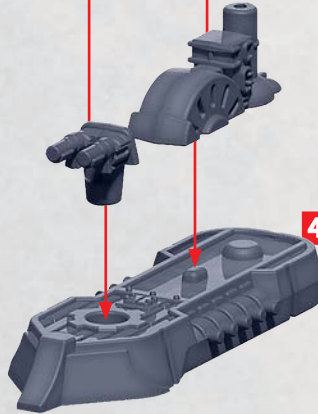

42-43

