

GOTHAM CARRIER

PARTS CAN BE FOUND AS RESIN AND ON THE ORE WAR VETERANS SQUADRONS SPRUES

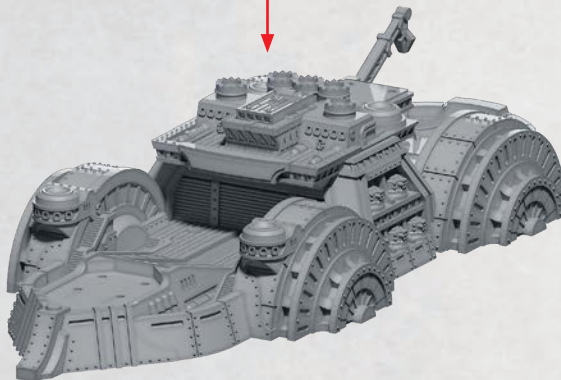
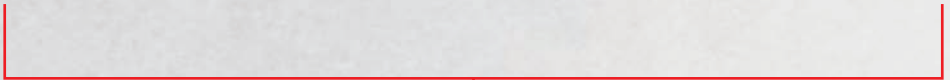
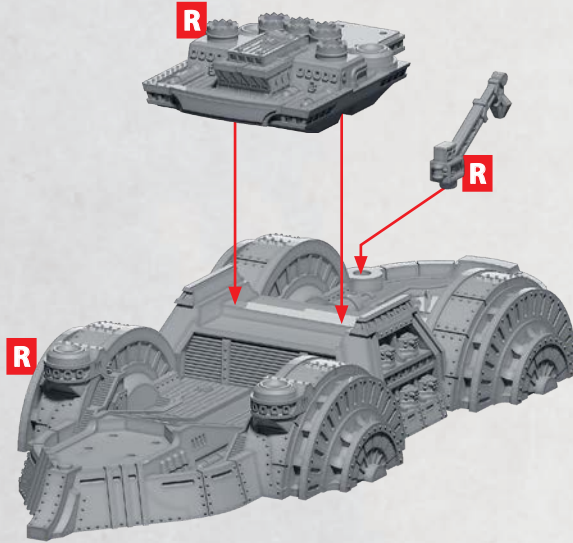

R = RESIN

GOTHAM CARRIER

PARTS CAN BE FOUND AS RESIN AND ON THE ORE WAR VETERANS SQUADRONS SPRUES

NOTE: PLASTIC AND RESIN TALONS ARE
INTERCHANGEABLE AND CAN BE PLACED ON ANY
OF THE THREE POSITIONS (A, B, C) SHOWN

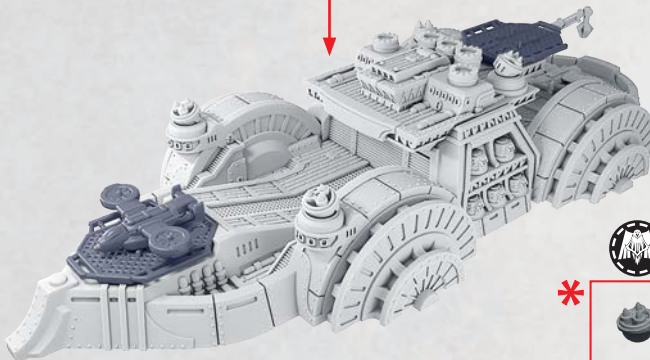
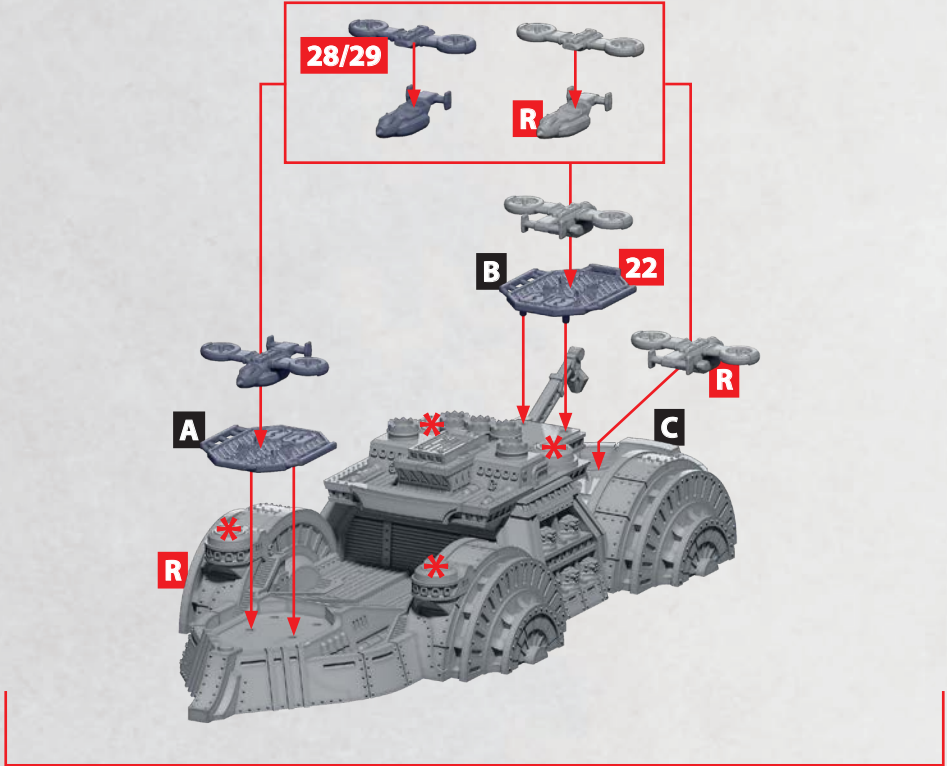

R = RESIN

* ALL ROCKETS ARE INTERCHANGEABLE



R



R

GETTYSBURG AND PROVIDENCE CLASS CRUISER HULL

PARTS CAN BE FOUND ON THE ORE WAR VETERANS SQUADRONS SPRUES

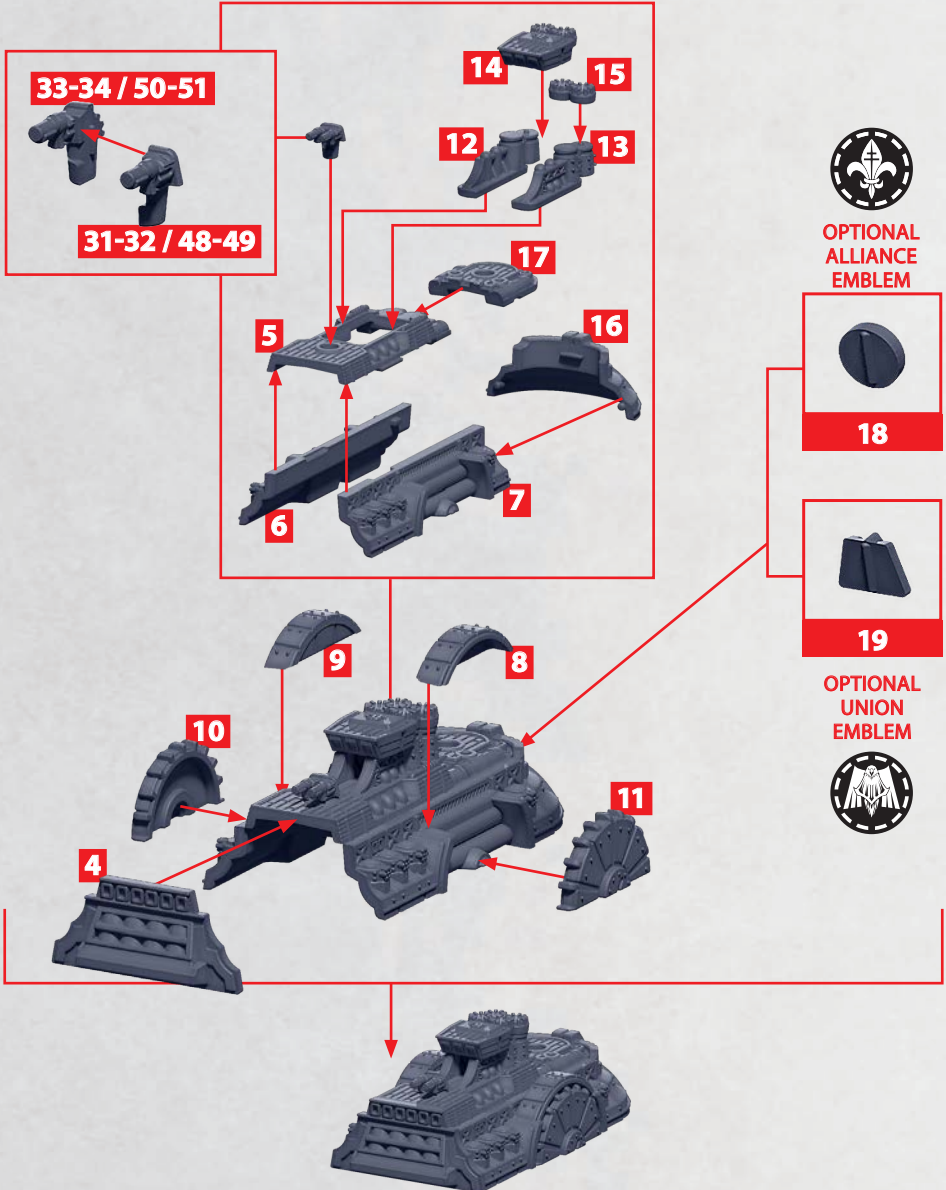

GETTYSBURG CLASS CRUISER

PARTS CAN BE FOUND ON THE ORE WAR VETERANS SQUADRONS SPRUES

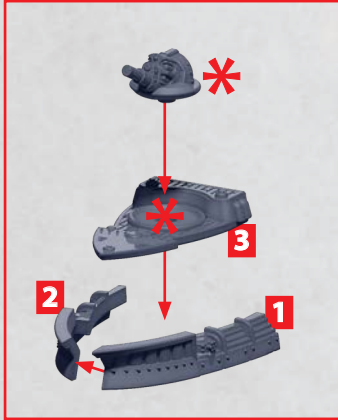

SEE PAGE 3
FOR GUN
ASSEMBLY



SEE PAGE 3
FOR AFT
ASSEMBLY



ALLIANCE
TURRETS



38 / 56-57



UNION
TURRETS



35 / 52-53

* ALL TURRETS ARE INTERCHANGEABLE

PROVIDENCE CLASS CRUISER

PARTS CAN BE FOUND ON THE ORE WAR VETERANS SQUADRONS SPRUES

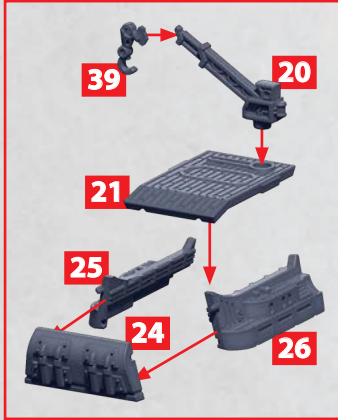

SEE PAGE 3
FOR GUN
ASSEMBLY

SEE PAGE 3
FOR AFT
ASSEMBLY

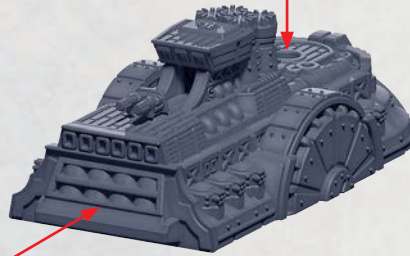
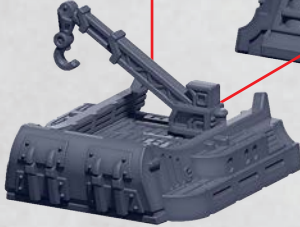

SPRINGFIELD CLASS CORVETTE

PARTS CAN BE FOUND ON THE ORE WAR VETERANS SQUADRONS SPRUES

33-34 / 50-51



31-32 / 48-49

46-47



44-45

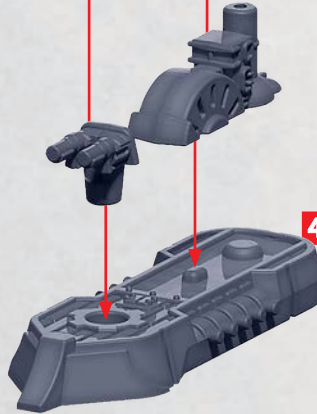

42-43

